

# SPECIFICATION

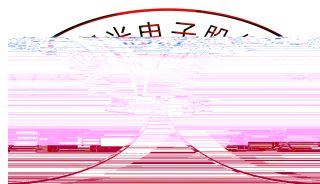

# Contents

1. Description	
1.1 General Description .....	3
1.2 Features .....	3
1.3 Application .....	3
1.4 Package Dimension .....	4
1.5 Product Parameters .....	5
1.6 Typical optical characteristics curves .....	6
2. Packaging	
2.1 Packaging Specification .....	9
2.1.1 Carrier Tape Dimension .....	9
2.1.2 Reel Dimension .....	10
2.1.3 Label Form Specification .....	10
2.2 Moisture Resistant Packing .....	11
2.3 Cardboard Box .....	11
2.4 Reliability Test Items And Conditions .....	12
2.5 Criteria For Judging Damage .....	12
3. SMT Reflow Soldering Instructions SMT	
3.1 SMT Reflow Soldering Instructions SMT .....	13
3.1.1 Soldering Iron .....	14
3.1.2 Repairing .....	14
3.1.3 Cautions .....	15
4. Handling Precautions	
4.1 Handling Precautions .....	15

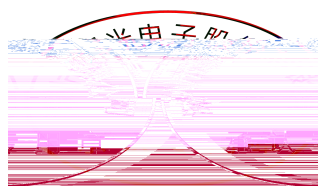

## 1. Description

### 1.1 General Description

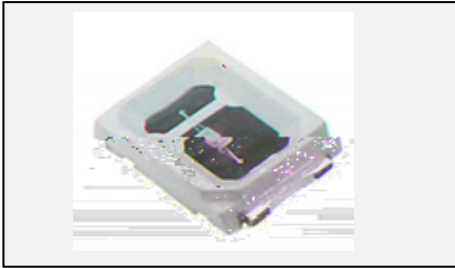

This production use the PLCC-2 package outline size 2.8\*3.5\*0.65mm

### 1.2 Features

- ▶ PLCC package.
- ▶ Viewing angle:120°.
- ▶ Suitable for all SMT assembly and solder process.
- ▶ Available on tape and reel.
- ▶ Moisture sensitivity level: Level 3.
- ▶ RoHS compliant.

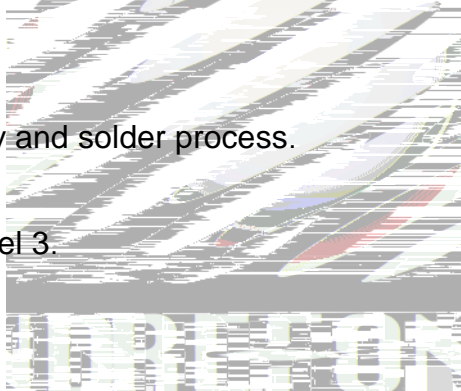

### 1.3 Application

- ▶ Flower production.
- ▶ Tissue culture.
- ▶ Plant factory.
- ▶ Refreshment.
- ▶ General use.

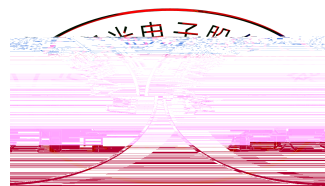

### 1.4 Package Dimension

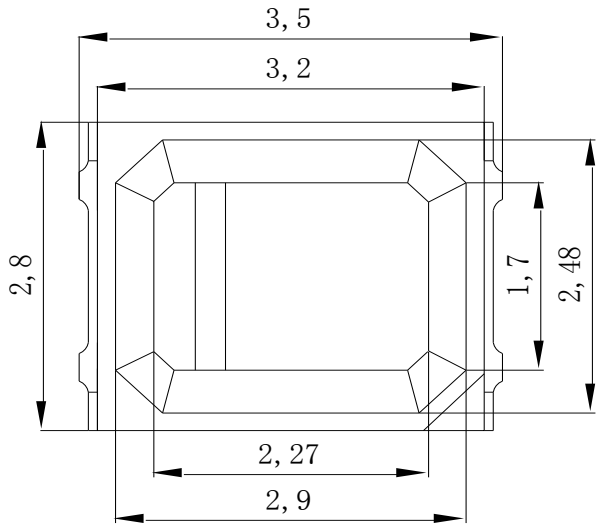

Fig.1-1 Top view

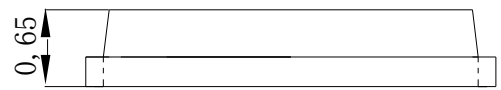

Fig.1-2 Side view

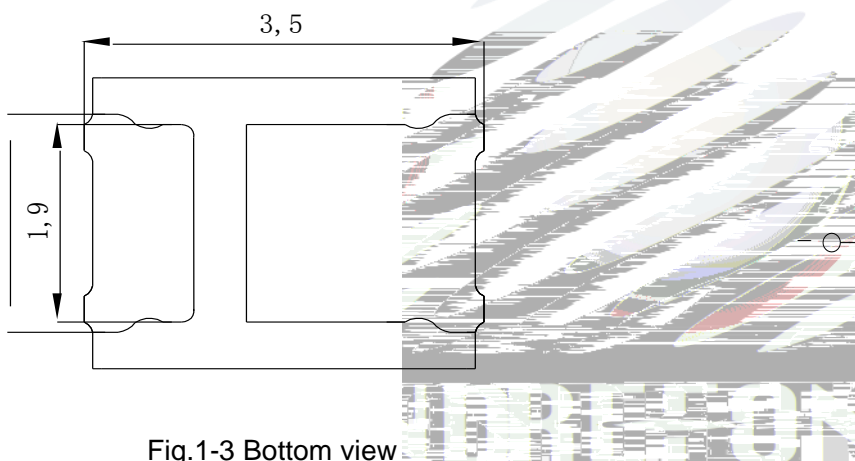

Fig.1-3 Bottom view

Fig.1-4 Polarity

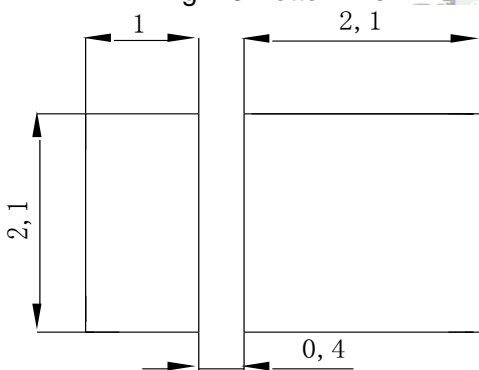

Fig.1-5 Soldering patterns

## 1.5 Product Parameters

Table 1-1 Electrical / Optical Characteristics at Ts=25°C

Item	Symbol	Test Condition	Value			Unit
			Min.	Typ	Max.	
Forward Voltage	$V_F$	$I_F=100mA$	2.8	3.4	3.6	V
Reverse Current	$I_R$	$V_R=5V$	---	---	10	$\mu A$
Total radiant flux	$\Phi_e$	$I_F=100mA$	140	180	224	mW
Peak wavelength	$\lambda_p$	$I_F=100mA$	440	450	455	nm
Viewing Angle	2 $\theta$ 1/2	$I_F=100mA$	---	120	---	deg
Thermal Resistance.	$R_{THJ-S}$	$I_F=100mA$	---	15	---	$^{\circ}W$

Table 1-2 Absolute Maximum Ratings at Ts=25°C

Parameter	Symbol	Rating	Units
Power Dissipation	$P_D$	0.3	W
Forward Current	$I_F$	100	mA
Peak Forward Current	$I_{FP}$	150	mA
Reverse Voltage	$V_R$	5	V
Electrostatic Discharge (HBM)	$E_{SD}$	2000	V
Operating Temperature	$T_{OPR}$	-40 ~ +85	
Storage Temperature	$T_{OPR}$	-40 ~ +100	
Junction Temperature	$T_J$	115	

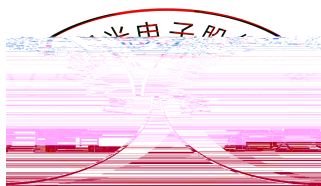

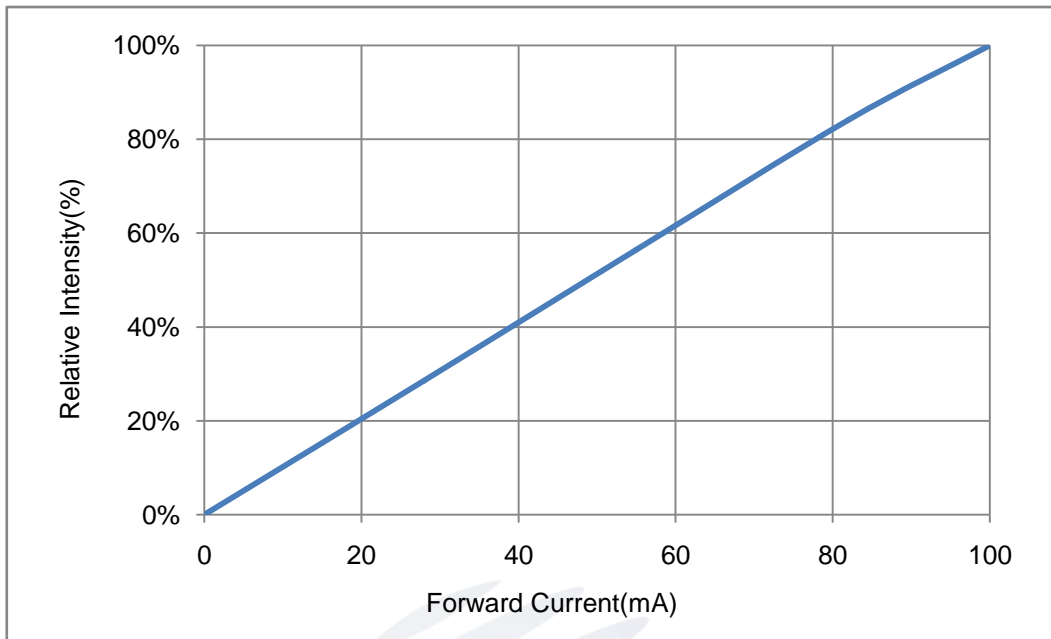

Fig.2- Forward Current Vs. Relative Power

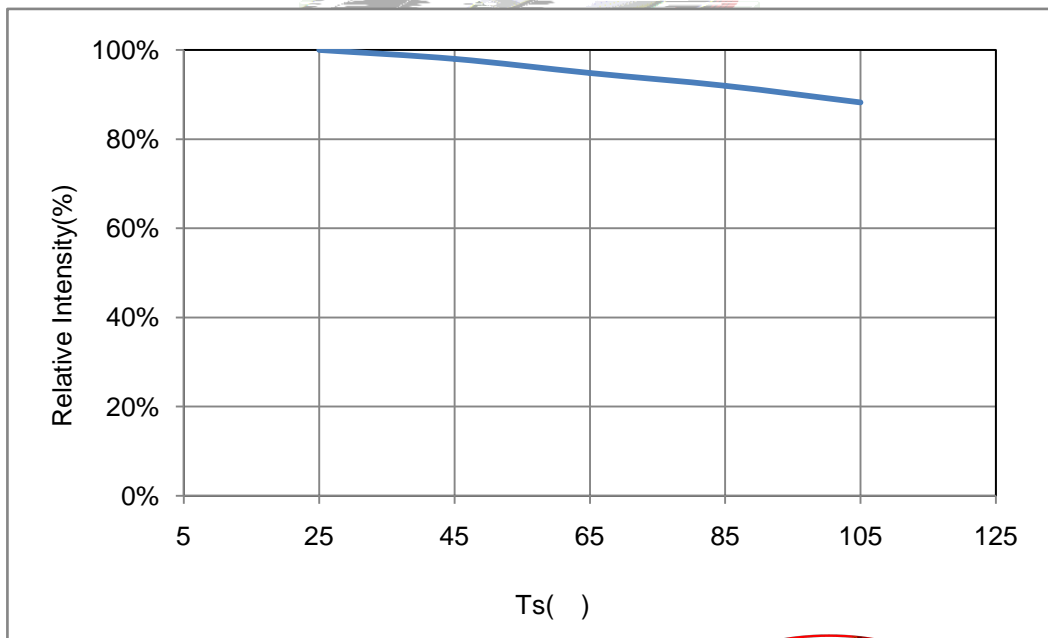

Fig.3-Solder Temperature VS. Relative Power



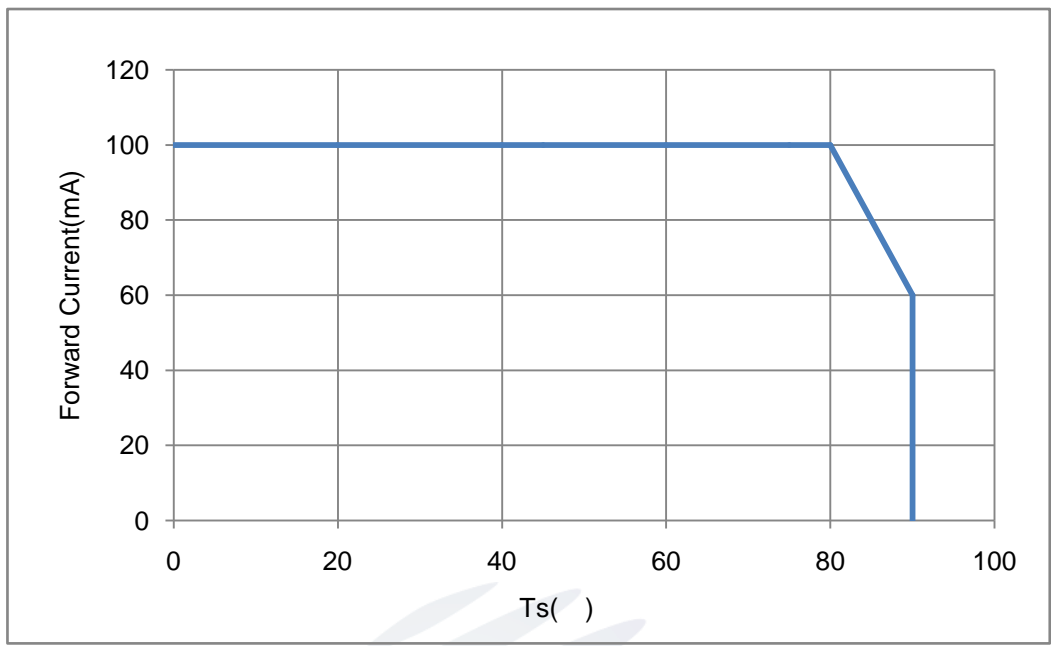

Fig.4-Ts Temperature VS. Forward Current

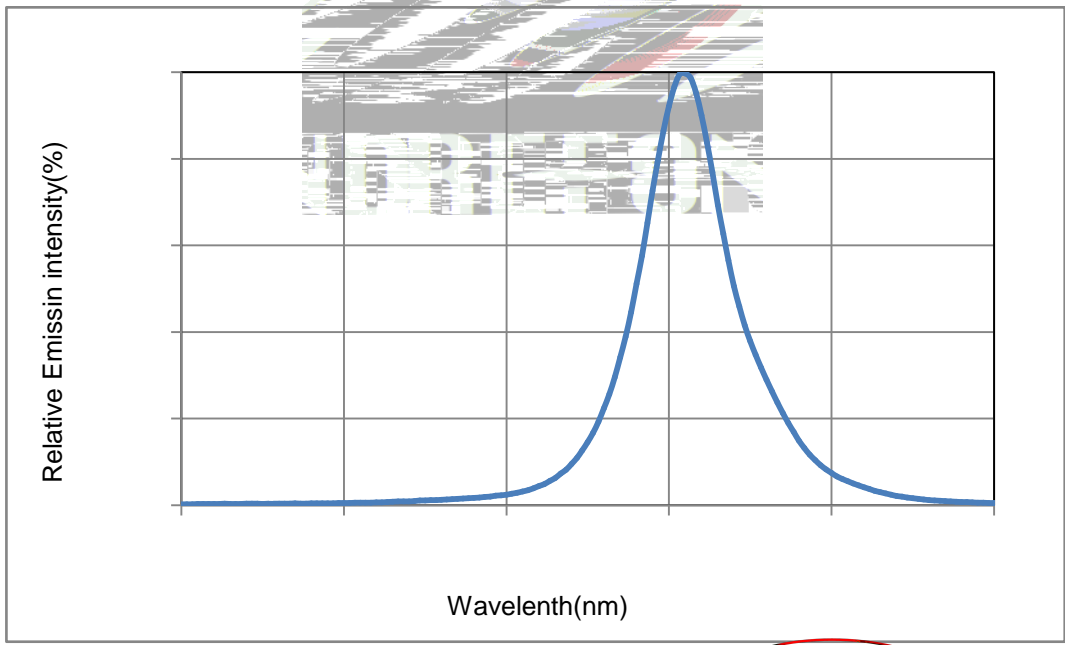

Fig.5-Spectrum Distribution



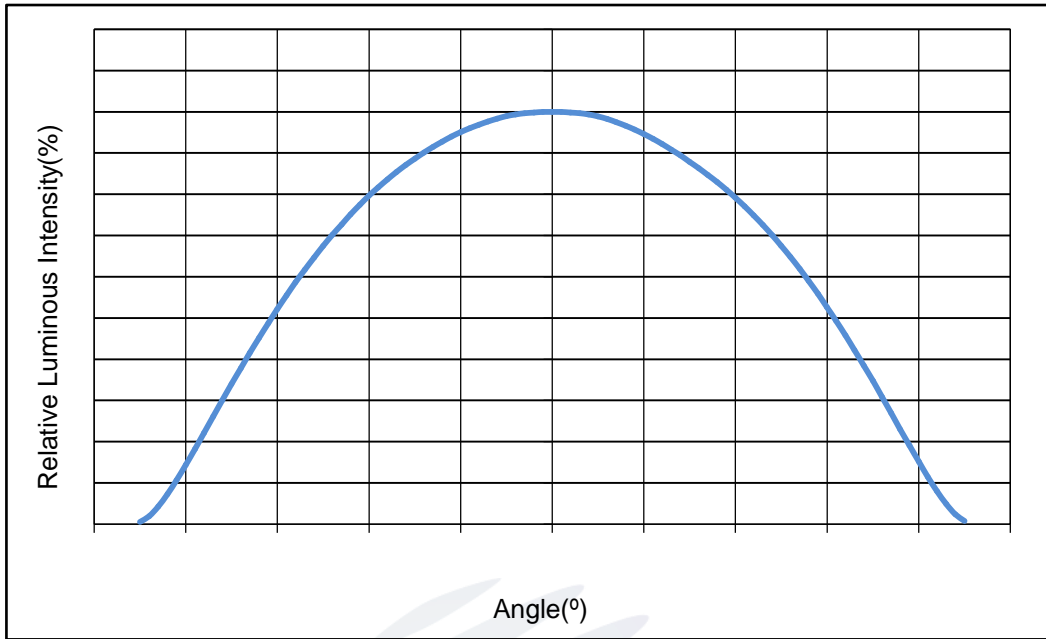

Fig.6- Radiation Diagram

## 2. Packaging

### 2.1 Packaging Specification

Package:4000pcs/reel.

#### 2.1.1 Carrier Tape Dimension

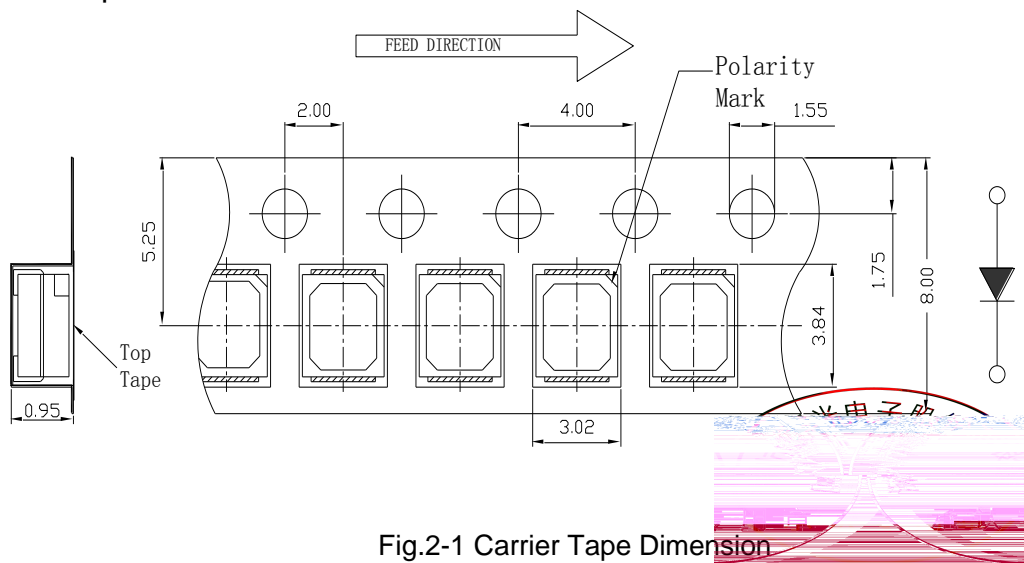

Fig.2-1 Carrier Tape Dimension



## 2.2 Moisture Resistant Packing

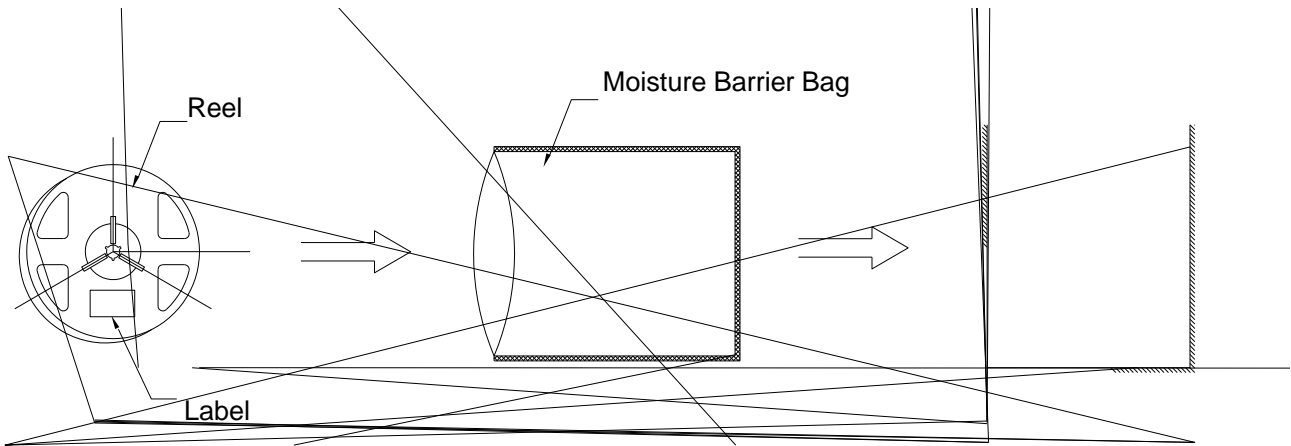

Fig.2-4



## 2.4 Reliability Test Items And Conditions

Table 2-3 Reliability Test Items And Conditions

Test Items	Ref.Standard	Test Condition	Time	Quantity	Ac/Re
Reflow	JESD22-B106	Temp:260 max T=10 sec	3times.	10Pcs.	0/1
Temperature Cycle	JESD22-A104	100 30 min. ↑↓5 min -40 30 min.	300 Cycles	10Pcs.	0/1
Thermal Shock	JESD22-A106	-40 15min ↑↓10s 100 15min	300 Cycles	10Pcs.	0/1
High Temperature Storage	JESD22-A103	Temp:100	1000Hrs.	10Pcs.	0/1
Low Temperature Storage	JESD22-A119	Temp:-40	1000Hrs.	10Pcs.	0/1
Life Test	JESD22-A108	T <sub>a</sub> =25 I <sub>F</sub> =100mA	1000Hrs.	10Pcs.	0/1

## 2.5 Criteria For Judging Damage

Table 2-4 Criteria For Judging Damage

Test Items	Symbol	Test Condition	Criteria For Judgement	
			Min.	Max.
Forward Voltage	V <sub>F</sub>	I <sub>F</sub> =100mA	-	U.S.L*)x1.1
Reverse Current	I <sub>R</sub>	V <sub>R</sub> = 5V	-	U.S.L*)x2.0
Total radiant flux	Φ <sub>e</sub>	I <sub>F</sub> =100mA	I .S.L*)x0.7	-

Notes:

1. U.S.L: Upper standard leve. L.S.L: Lower standard level.
2. The above reliability tests is based on the verification of a single/strip LED of Refond's existing experimental platform, the reliability experiment was taken under good heat dissipation conditions. when customers applies the LED to the series and parallel circuit, should take consideration of all the factors such as the current, voltage distribution, heat dissipation and others.
3. The technical information shown in the data sheets is limited to the typical characteristics and circuit examples of the referenced products. It does not constitute the warranting of industrial property nor the granting of any license.



### 3. SMT Reflow Soldering Instructions SMT

#### 3.1 SMT Reflow Soldering Instructions SMT

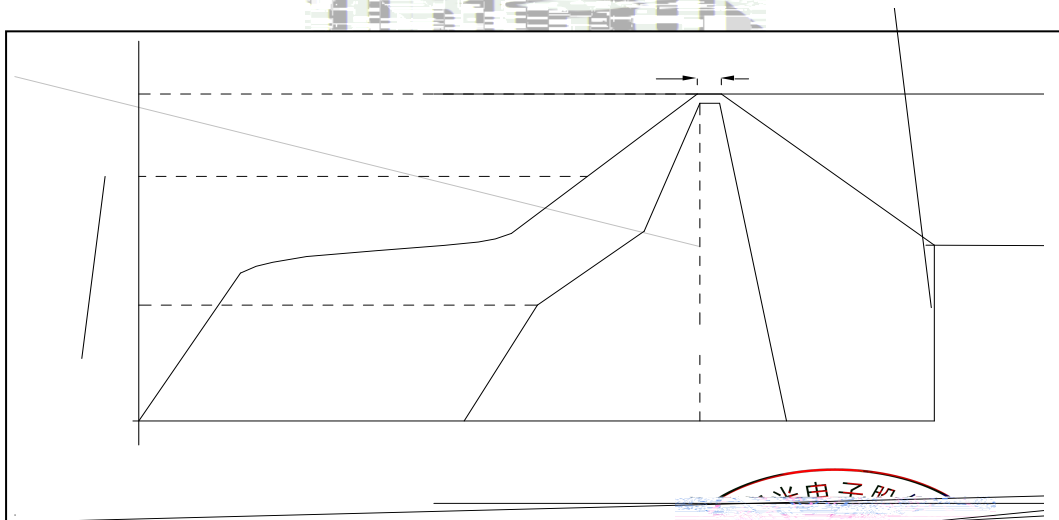

Fig.3-1 SMT Reflow Soldering Instructions SMT

Table 3-1 SMT Reflow Soldering Instructions SMT

Average temperature rise speed (T <sub>smax</sub> )	Max 3 °C/ s
Preheating: minimum temperature (T <sub>smin</sub> )	150 °C

Preheating: Max temperature (T<sub>smax</sub>)



### 3.1.3 Cautions

- (1) The encapsulated material of the LEDs is silicone. Therefore the LEDs have a soft surface on the top of package. The pressure to the top surface will be impacted on the reliability of the LEDs. Precautions should be taken to avoid the strong pressure on the encapsulated part. So when use the picking up nozzle, the pressure on the silicone resin should be proper.
- (2) Components should not be mounted on warped (non coplanar) portion of PCB. After soldering, do not warp the circuit board.
- (3) Do not apply mechanical force or excess vibration during the cooling process to normal temperature after soldering. Do not rapidly cool device after soldering.

## 4. Handling Precautions

### 4.1 Handling Precautions

- (1) LED operating environment and sulfur element composition cannot be over 100PPM in the LED mating usage material. This is provided for informational purposes only and is not a warranty or endorsement.
- (2) In order to prevent external material from getting into the inside of LED, which may cause the malfunction of LED, the single content of Bromine element is required to be less than 900PPM, the single content of Chlorine element is required to be less than 900PPM, the total content of Bromine element and Chlorine element in the external materials of the application products is required to be less than 1500PPM. This is provided for informational purposes only and is not a warranty or endorsement.
- (3) VOCs (Volatile organic compounds) emitted from materials used in the construction of fixtures can penetrate silicone encapsulants of LEDs and discolor when exposed to heat and photonic energy. The result can be a significant loss of light output from the fixture. Knowledge of the properties of the materials selected to be used in the construction of fixtures can help prevent these issues. Refond advises against the use of any chemicals or materials that have been found or are suspected to have an adverse effect on device performance or reliability. To verify compatibility, Refond recommends that all chemicals and materials be tested in the specific application and environment for which they are intended to be used. Attaching LEDs, do not use adhesives that outgas organic vapor.

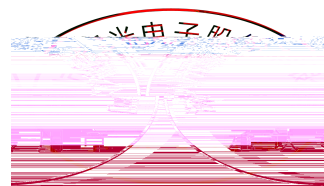

(4) Handle the component along the side surface by using forceps or appropriate tools; Do not directly touch or Handle the silicone lens surface, it may damage the internal circuitry.

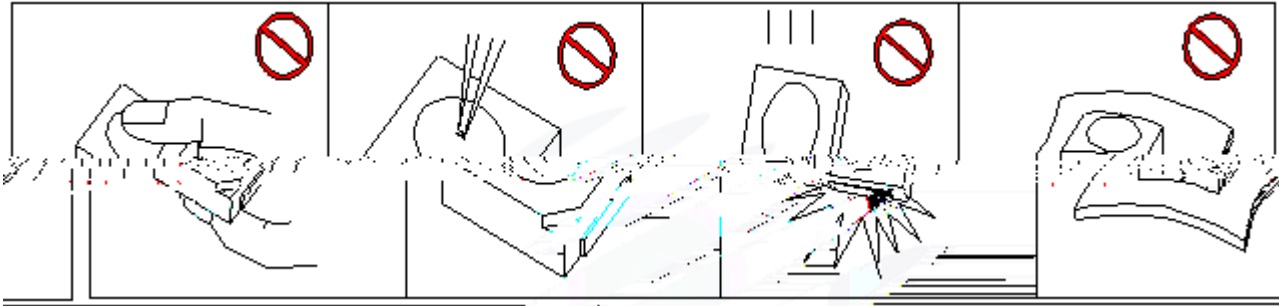

Fig 4-1 Operate Method

(5) In designing a circuit, the current through each LED can not exceed the absolute maximum rating specified for each LED. In the meanwhile, resistors for protection should be applied, otherwise slight voltage shift will cause big current change, burn out may happen. The driving circuit must be designed to allow forward voltage only when it is ON or OFF. If the reverse voltage is applied to LED, migration can be generated resulting in LED damage.

(6) Thermal Design is paramount importance because heat generation may result in the Characteristics decline, such as brightness decreased, Color change and so on. Please consider the heat generation of the LEDs when making the system design.

(7) Compared to standard encapsulants, silicone is generally softer, and the surface is more likely to attract dust, requiring special care during processing. In cases where a minimal level of dirt and dust particles cannot be guaranteed, a suitable cleaning solution must be applied to the surface after the soldering of components. Refond suggests using isopropyl alcohol for cleaning. In case other solvents are used, it must be assured that these solvents do not dissolve the package or resin. Ultrasonic cleaning is not recommended. Ultrasonic cleaning may cause damage to the LED.

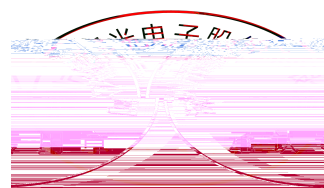



Table 4-1Storage

Conditions		Temperature	Humidity	Time
Storage	Before Opening Aluminum Bag	≤30°C	≤75%	Within 1 Year From Date
	After Opening Aluminum Bag	≤30°C	≤60%	24hours
Baking		60±5°C	-	≥24hours

(8) If the moisture absorbent material silica gel has faded away or the LEDs have exceeded the storage time, baking treatment should be performed after unpacking and based on the following condition 65 5 for above 24 hours.

If the package is flatulence or damaged, please notify the sales staff to assist.

(9) Similar to most Solid state devices; LEDs are sensitive to Electro-Static Discharge (ESD) and Electrical Over Stress (EOS).

(10) Other points for attention, please refer to our relevant information.

