

# SPECIFICATION

LT P/N

LT2204WH-A-GL

Mass Product

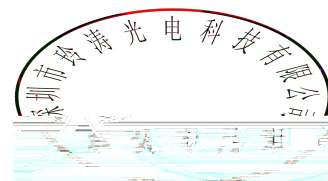

## Contents

1. Description	3
1.1 General Description	3
1.2 Features	3
1.3 Application	3
1.4 Package Dimension	4
1.5 Product Parameters	4
1.6 Bin Range Of Forward Voltage and Luminous Intensity (IF=20mA)	BIN
(IF=20mA)	6
1.7 Typical Optical Characteristics Curves	6
2. Packaging	10
2.1 Packaging Specification	10
2.1.1 Carrier Tape Dimension	10
2.1.2 Reel Dimension	12
2.1.3 Label Form Specification	11
2.2 Moisture Resistant Packing	11
2.3 Cardboard Box	11
2.4 Reliability Test Items And Conditions	11
2.5 Criteria For Judging Damage	12
3. SMT Reflow Soldering Instructions SMT	13
3.1 SMT Reflow Soldering Instructions SMT	13
4. Handling Precautions	15
4.1 Handling Precautions	15

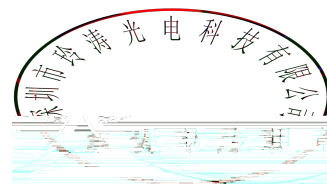

## 1. Description

### 1.1



The White LED, which was fabricated by using a blue chip and the phosphor.

Product Package: 2.23mmX0.4mmX0.5mm.

### 1.2 Features

PLCC Package. PLCC

Wide viewing angle.

Suitable for all SMT assembly and solder process.

Available on tape and reel.

Moisture sensitivity level: Level 3.

RoHS compliant.

### 1.3 Application

LCD Back Light. LCD

Mobile Phones.

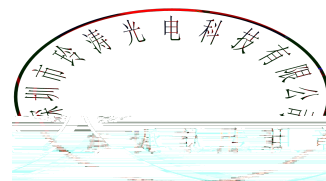

## 1.4 Package Dimension

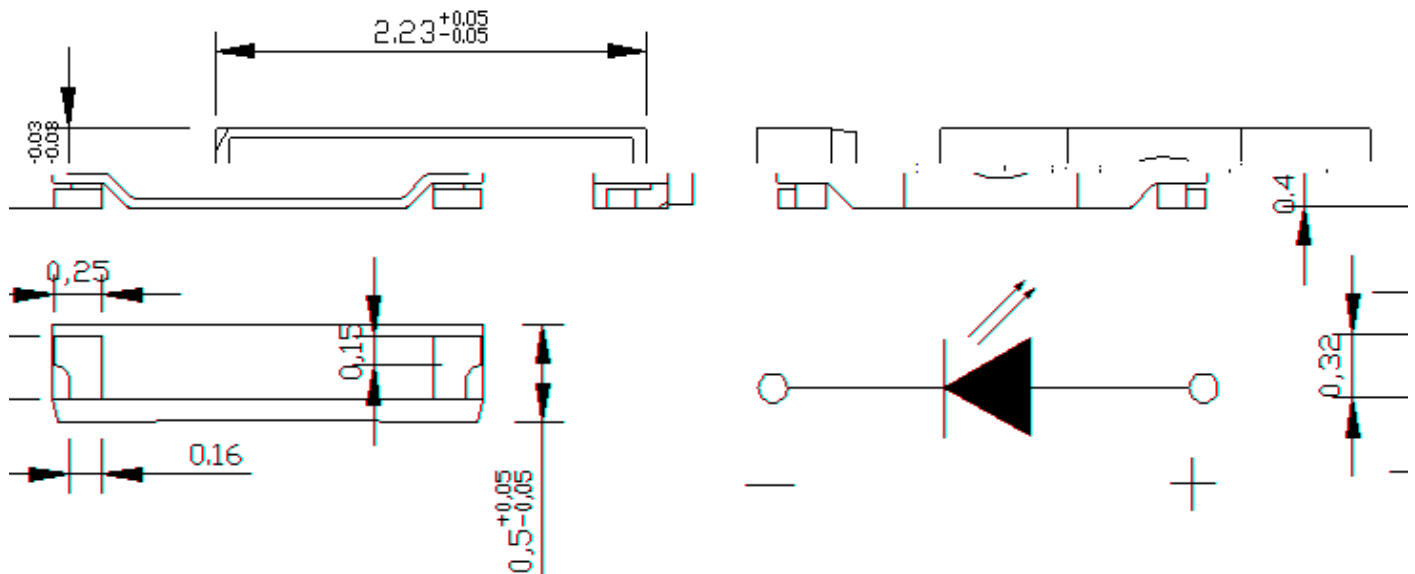

### Notes

All dimensions units are millimeters

All dimensions tolerances are  $\pm 0.1$ mm unless otherwise noted.

±

## 1.5 Product Parameters

Table 1-1 Electrical / Optical Characteristics at  $T_s=25^\circ\text{C}$

Item	Symbol	Test Condition	Value			Unit
			Min.	Typ.	Max.	
Forward Voltage	$V_F$	$I_F=20\text{mA}$	---	2.8	---	V
Reverse Current	$I_R$	$V_R=5\text{V}$	---	---	10	$\mu\text{A}$
Luminous Intensity	$I_v$	$I_F=20\text{mA}$	---	2750	---	mcd
Viewing Angle		$I_F=20\text{mA}$	---	120	---	deg

Table 1-2 Absolute Maximum Ratings at Ts=25°C

Parameter	Symbol	Rating	Units
Forward Current	I <sub>F</sub>	30	mA
Peak Forward Current	I <sub>FP</sub>	100	mA
Reverse Voltage	V <sub>R</sub>	5	V
Electrostatic Discharge (HBM)	E <sub>SD</sub>	2000	V
LED Junction Temperature (LED )	T <sub>J</sub>	105	
Operating Temperature	T <sub>OPR</sub>	-30 ~ + 85	
Storage Temperature	T <sub>STG</sub>	-40~+100	

Notes

- 1/10 Duty cycle, 0.1ms pulse width.
- The above forward voltage measurement allowance tolerance is  $\pm 0.03V$ .  $\pm 0.03V$
- The above color coordinates measurement allowance tolerance is  $\pm 0.003$ .  $\pm 0.003$
- The above luminous intensity measurement allowance tolerance  $\pm 3\%$ .  $\pm 3\%$
- Care is to be taken that power dissipation does not exceed the absolute maximum rating of the product.
- All measurements were made under the standardized environment of LT.
- When the LEDs are in operation the maximum current should be decided ~~after~~ ~~measuring~~ the package temperature, junction temperature should not exceed the maximum rate

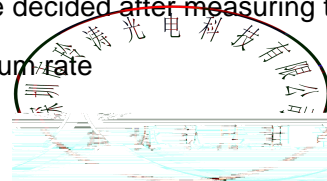

## 1.6 Bin Range Of Forward Voltage and Luminous Intensity (IF=20mA) BIN (IF=20mA)

Table 1-3 Bin Range Of Luminous Intensity

BIN CODE	IF=20mA Test			
	Min(mcd)	Max(mcd)	Min(lm)	Max(lm)
30	2150	2250	6.00	6.25
31	2250	2350	6.25	6.50
32	2350	2450	6.50	6.75
33	2450	2550	6.75	7.00
34	2550	2650	7.00	7.25
35	2650	2750	7.25	7.50
36	2750	2850	7.50	7.75
37	2850	2950	7.75	8.00
38	2950	3050	8.00	8.25
39	3050	3150	8.25	8.50
40	3150	3250	8.50	8.75
41	3250	3350	8.75	9.00
42	3350	3450	9.00	9.25

Table 1-4 Bin Range Of Forward Voltage

BIN CODE	Min.	Max.	Unit	Condition
V0	2.7	2.8	V	IF=20mA
V1	2.8	2.9		
V2	2.9	3.0		
V3	3.0	3.1		
V4	3.1	3.2		
V5	3.2	3.3		

### Notes

VF Tolerance:  $\pm 0.03V$  @ IF= 20mA @ Ta=25

IV Tolerance:  $\pm 3\%$  @ IF= 20mA @ Ta=25

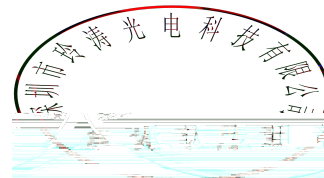

Fig. 1-5 The C.I.E. 1931 Chromaticity Diagram:

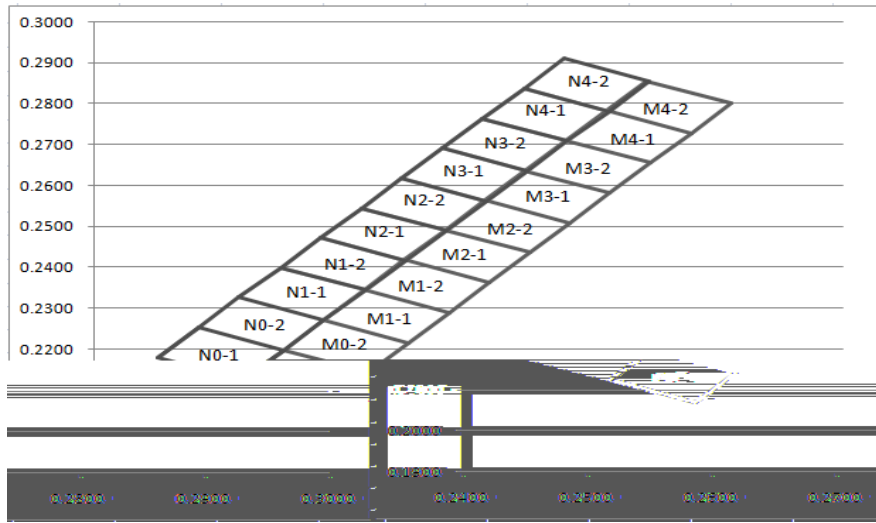
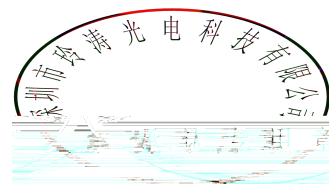

Table 1-6 Bin Range of Chromaticity Coordinates Block

N0-1	0.2451	0.2180	N0-2	0.2484	0.2253	N1-1	0.2516	0.2326
	0.2484	0.2253		0.2516	0.2326		0.2549	0.2399
	0.2552	0.2198		0.2584	0.2271		0.2617	0.2344
	0.2519	0.2125		0.2552	0.2198		0.2584	0.2271
N1-2	0.2549	0.2399	N2-1	0.2581	0.2472	N2-2	0.2614	0.2545
	0.2581	0.2472		0.2614	0.2545		0.2646	0.2618
	0.2649	0.2417		0.2682	0.2490		0.2714	0.2563
	0.2617	0.2344		0.2649	0.2417		0.2682	0.2490
N3-1	0.2646	0.2618	N3-2	0.2679	0.2691	N4-1	0.2711	0.2764
	0.2679	0.2691		0.2711	0.2764		0.2744	0.2837
	0.2747	0.2636		0.2779	0.2709		0.2812	0.2782
	0.2714	0.2563		0.2747	0.2636		0.2779	0.2709
N4-2	0.2744	0.2837	M0-1	0.2519	0.2125	M0-2	0.2552	0.2198
	0.2776	0.2910		0.2552	0.2198		0.2584	0.2271
	0.2844	0.2855		0.2620	0.2143		0.2652	0.2216
	0.2812	0.2782		0.2587	0.2070		0.2620	0.2143
M1-1	0.2584	0.2271	M1-2	0.2616	0.2345	M2-1	0.2648	0.2418
	0.2616	0.2345		0.2648	0.2418		0.2681	0.2491
	0.2684	0.2290		0.2716	0.2363		0.2749	0.2436
	0.2652	0.2216		0.2684	0.2290		0.2716	0.2363
M2-2	0.2681	0.2491	M3-1	0.2713	0.2564	M3-2	0.2745	0.2637
	0.2713	0.2564		0.2745	0.2637		0.2777	0.2710
	0.2781	0.2509		0.2813	0.2582		0.2845	0.2655
	0.2749	0.2436		0.2781	0.2509		0.2813	0.2582



	0.2777	0.2710		0.2810	0.2783
M4-1			M4-2		





## 1.7 Typical Optical Characteristics Curves

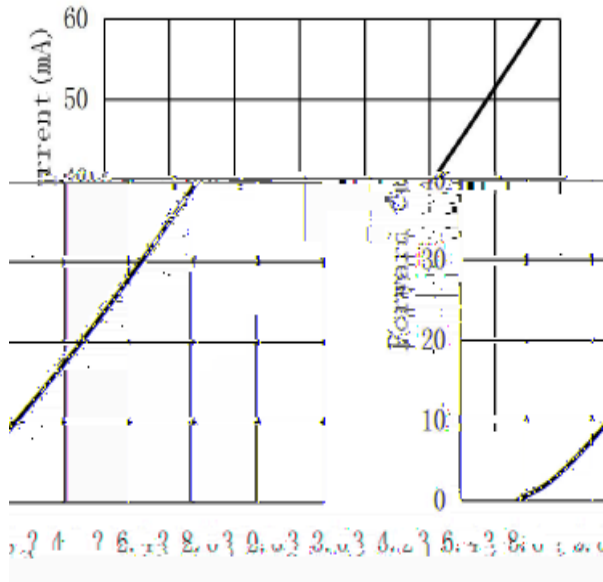

Fig. 1-9 Forward Voltage Vs Forward Current

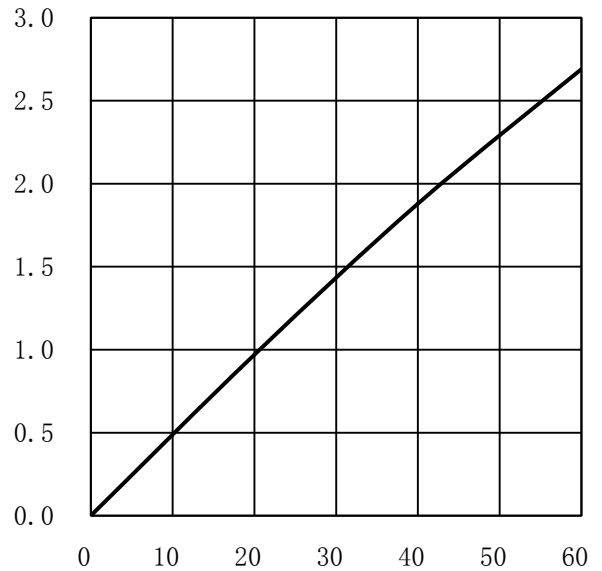

Fig. 1-10 Forward Current Vs Relative Intensity

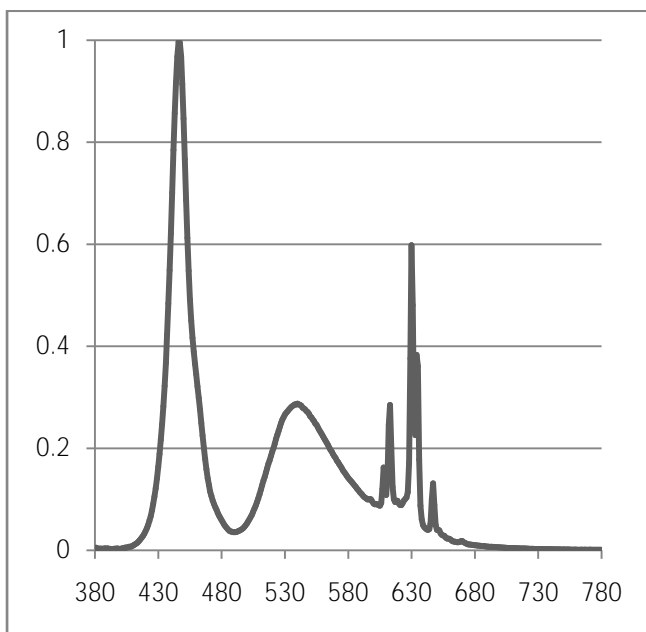

Fig. 1-11 Spectrum Distribution

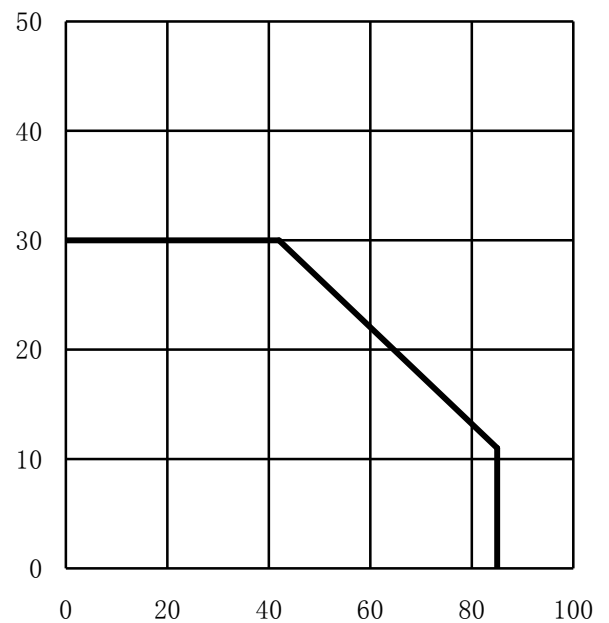
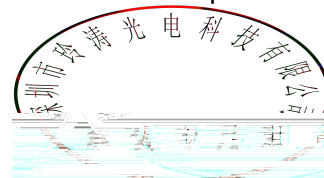

Fig 1-12 Solder Temperature Vs Forward Current





## 2.1.2 Label Form Specification

Table 2-2 Label Map



Table 2-3 Label Form Specification

PART NO.	Part Number
BIN CODE	Bin Code
IV	Luminous intensity
V <sub>F</sub>	Forward Voltage
WL	Wavelength
QTY	Packing Quantity
DATE	Made Date
LOT NO	Lot Number

## 2.2 Moisture Resistant Packing

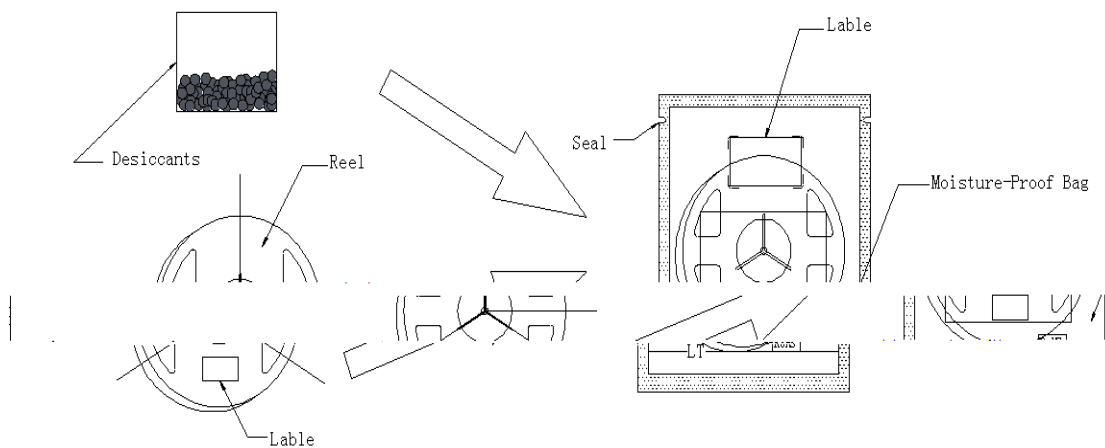

Fig.2-4 Moisture Resistant Packing

## 2.3 Cardboard Box

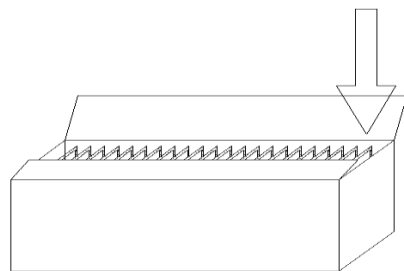
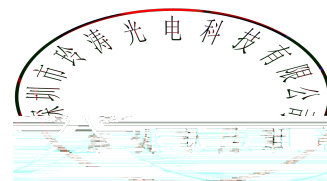

Fig.2-5 Cardboard Box



## 2.4 Reliability Test Items And Conditions

Table 2-6 Reliability Test Items And Conditions

Test Items	Test Condition	Time	Quantity	Ac/Re /
Reflow	Temp:260 max T=10 sec	---	20pcs.	0/1
Thermal Shock	-40 20min 5min 100 20min	100 cycle	20pcs.	0/1
High Temperature Storage	Temp:100	1000hrs.	20pcs.	0/1
Low Temperature Storage	Temp:-40	1000hrs.	20pcs.	0/1
Life Test	Ta=25 If=20mA	1000hrs.	20pcs.	0/1
High Temperature and Humidity storage	60 / 90%RH	1000hrs.	20pcs.	0/1
Temperature Humidity Operation Life	60 / 90%RH If=15mA	500hrs	20pcs.	0/1

## 2.5 Criteria For Judging Damage

Table 2-7 Criteria For Judging Damage

Test Items	Symbol	Test Condition	Criteria For Judgement	
			Min.	Max.
Forward Voltage	V <sub>F</sub>	I <sub>F</sub> =20mA	-	(U.S.L*)x1.1

Reverse Current	$I_R$	$V_R = 5V$	-	$>U.S.L^*) \times 2.0$
Luminous Flux		$I_F = 20mA$	$<L.S.L^*) \times 0.7$	-

Notes

- 1.U.S.L: Upper standard level                      L.S.L: Lower standard level
- 2.The above reliability tests is based on the verification of a single/strip LED of LT existing experimental platform,the reliability experiment was taken under good heat dissipation conditions. when customers applies the LED to the series and parallel circuit, should take consideration of all the factors such as the current, voltage distribution, heat dissipation and others.
- 3.The technical information shown in the data sheets is limited to the typical characteristics and circuit examples of the referenced products. It does not constitute the warranting of industrial property nor the granting of any license.

### 3. SMT Reflow Soldering Instructions SMT

#### 3.1 SMT Reflow Soldering Instructions

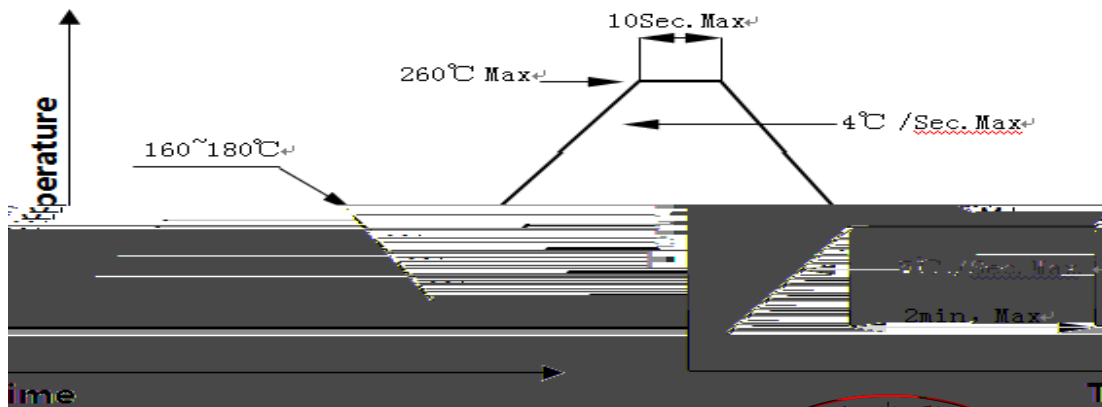

Fig.3-1 SMT Reflow Soldering Map

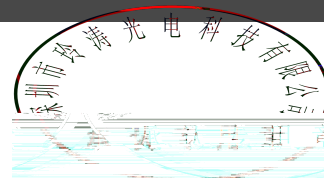

Fig.3-2 SMT Reflow Soldering Instructions SMT

Average temperature rise speed	T <sub>smax</sub> T <sub>P</sub>	5 °C/ Max 5 °C/ s
Preheating: minimum temperature	(T <sub>smin</sub> )	160 °C
Preheating: Max temperature	(T <sub>smax</sub> )	260 °C
Preheating: Time	T <sub>smin</sub> T <sub>smax</sub>	60 - 120 60s-120s
Time limited to maintain high temperature: the temperature	(T <sub>L</sub> )	217 °C
Time limited to maintain high temperature: The Time	(t <sub>L</sub> )	60 Max 60s
Peak /Classification of temperature:	/ (T <sub>P</sub> )	260 °C
Time limit classification of peak temperature time	t <sub>p</sub>	10 Max 10s
(T <sub>P</sub> ) 5 °C Hold time within 5 ° C with the actual peak temperature (TP)		30 Max 30s
Cooling speed		6 °C/ Max 6 °C/ s
25 °C Needed time from 25 °C to T <sub>p</sub>		8 Max 8 minutes

#### Notes

(1)Reflow soldering should not be done more than twice. If more than 24 hours between the two solderings , LED will be damaged.

(2)Whensoldering , do not put stress on the LEDs during heating.

#### 3.1.1 Soldering Iron

(1) When do soldering by hand, keep the temperature of iron below less 300°C less than 3 seconds.

(2) Soldering by hand should be done only one time.

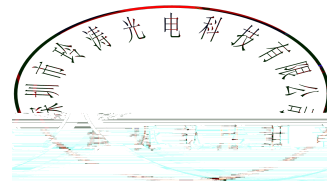

### 3.1.2 Repairing

Repairing shou0135 1 Tm[Re]-6(p)-3(a)g

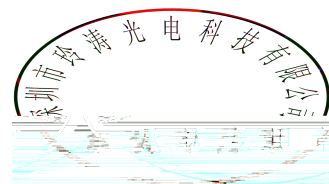

content of Bromine element and Chlorine element in the external materials of the application products is required to be less than 1500PPM. This is provided for informational purposes only and is not a warranty or endorsement.

(3) VOCs (Volatile organic compounds) emitted from materials used in the construction of fixtures can penetrate silicone encapsulants of LEDs and discolor when exposed to heat and photonic energy. The result can be a significant loss of light output from the fixture. Knowledge of the properties of the materials selected to be used in the construction of fixtures can help prevent these issues. LT advises against the use of any chemicals or materials that have been found or are suspected to have an adverse effect on device performance or reliability. To verify compatibility, LT recommends that all chemicals and materials be tested in the specific application and environment for which they are intended to be used. Attaching LEDs, do not use adhesives that outgas organic vapor.

(4) Handle the component along the side surface by using forceps or appropriate tools; do not directly touch or handle the silicone lens surface, it may damage the internal circuitry.

(5) In designing a circuit, the current through each LED must exceed the absolute maximum rating specified for each LED. In the meanwhile, resistors for protection should be applied, otherwise slight voltage shift will cause big current change, burn out may happen. The driving circuit must be designed to allow forward voltage only when it is ON or OFF. If the reverse voltage is applied to LED, migration can be generated resulting in LED damage.

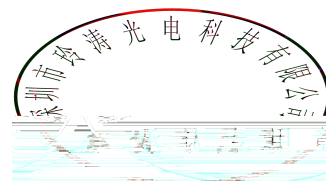





following condition (

Version History/

Date	Revisor	Version	Verifier	Remarks
2019/5/28		E/0		

