

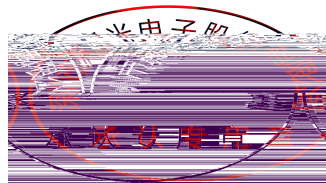

瑞豐光電

REUFENG OPTOELECTRONICS







瑞豐光電

RESEARCH & DEVELOPMENT



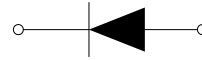
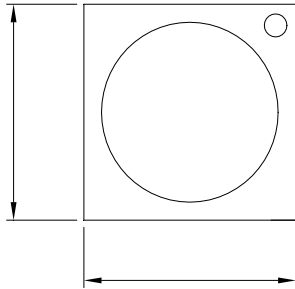

Anode
Cathode

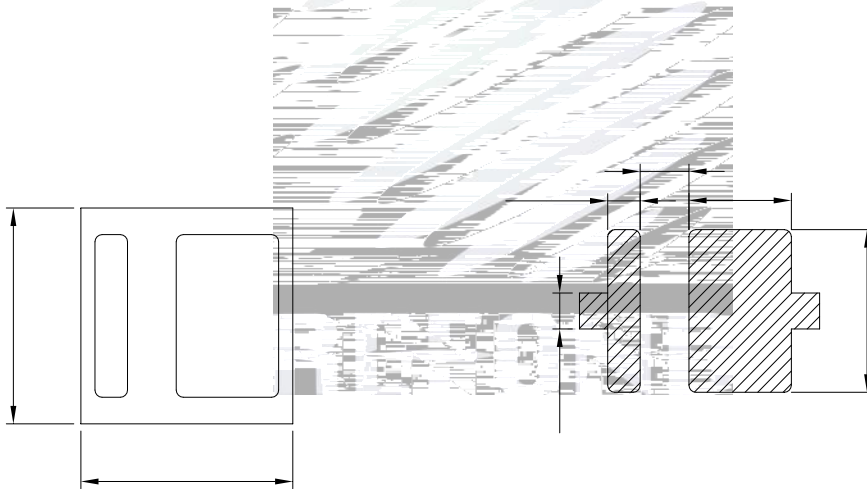

±

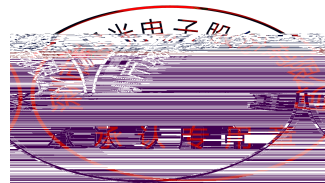

	λ					

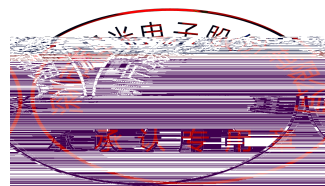
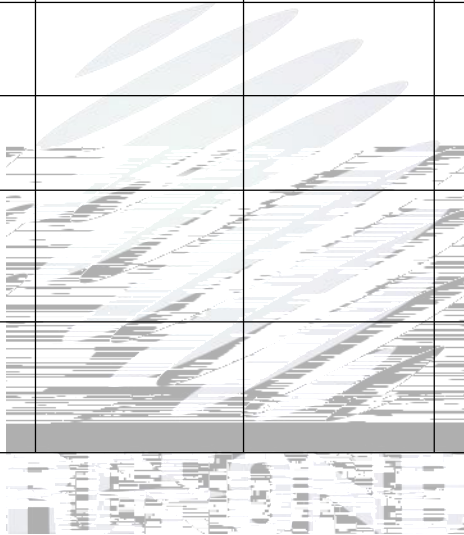

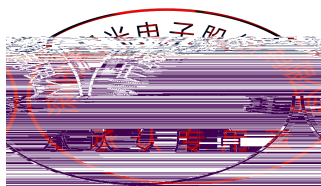

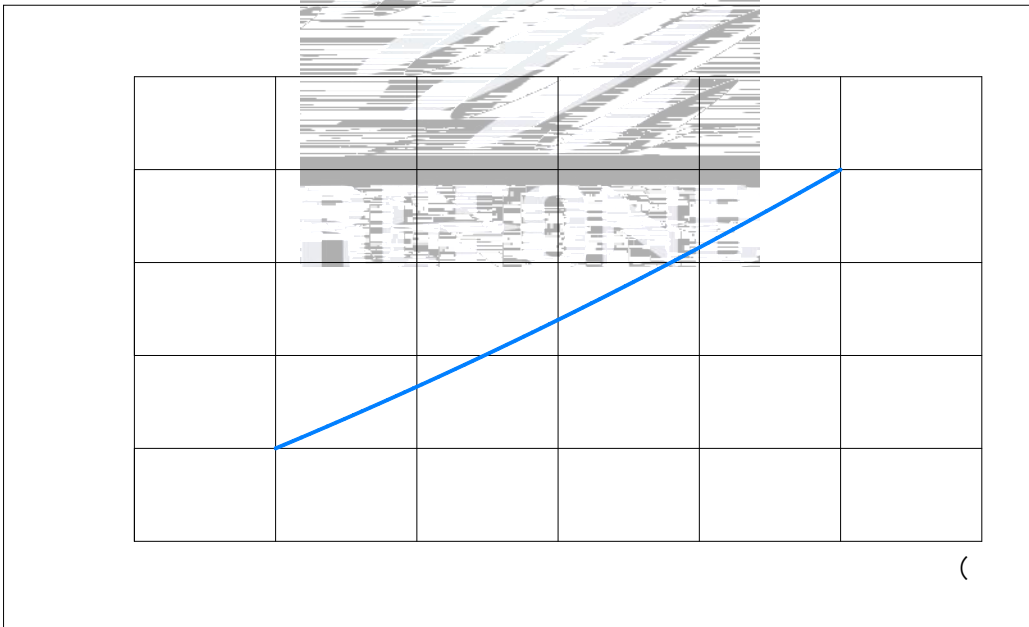
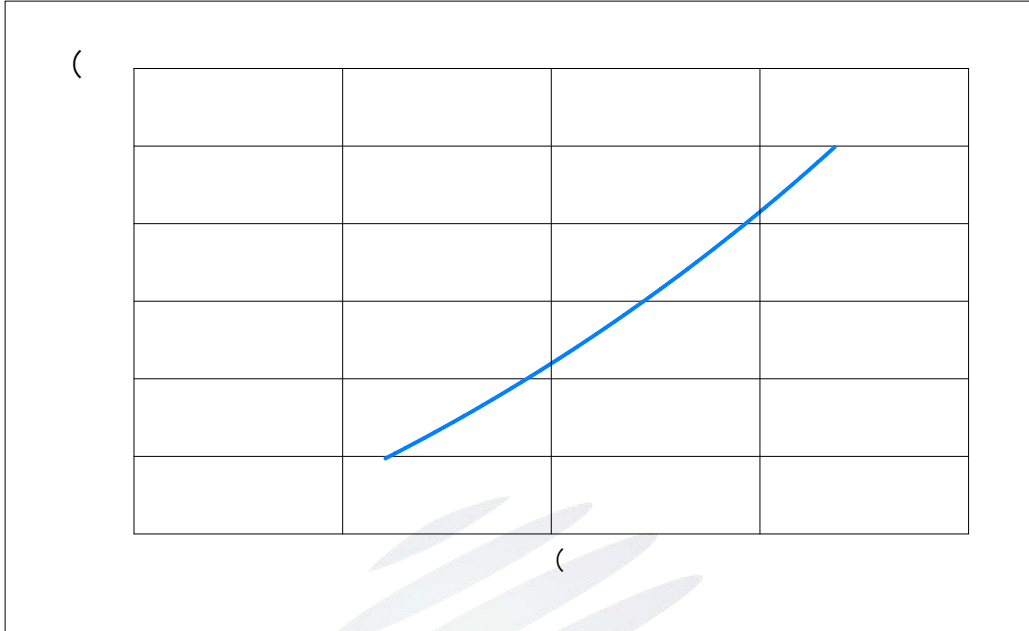

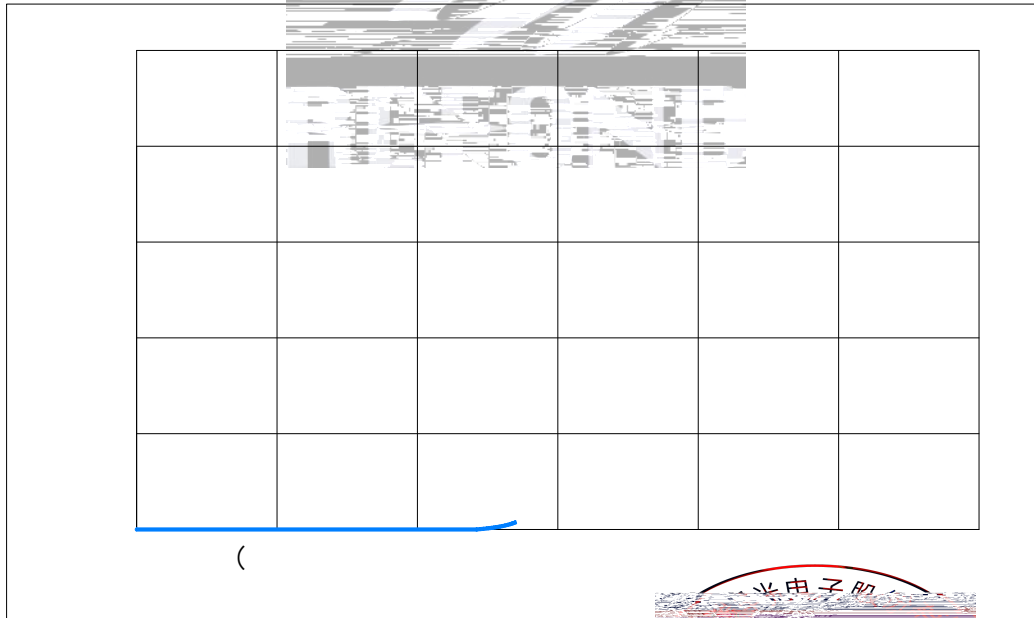
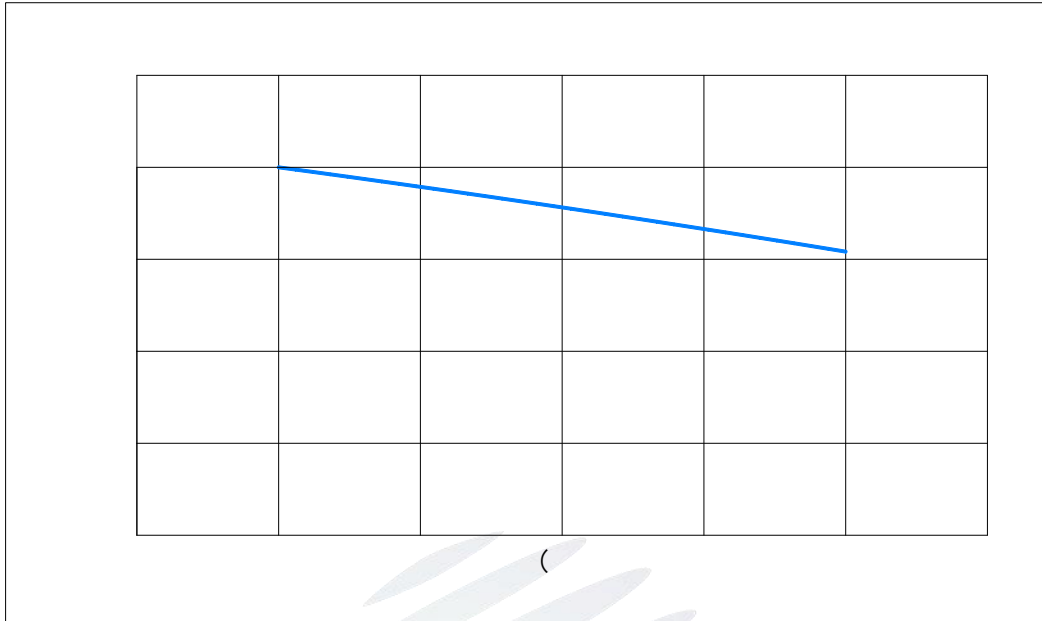



瑞豐光電

INTEGRATED OPTOELECTRONIC SOLUTIONS

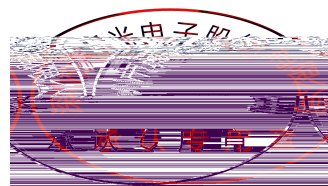
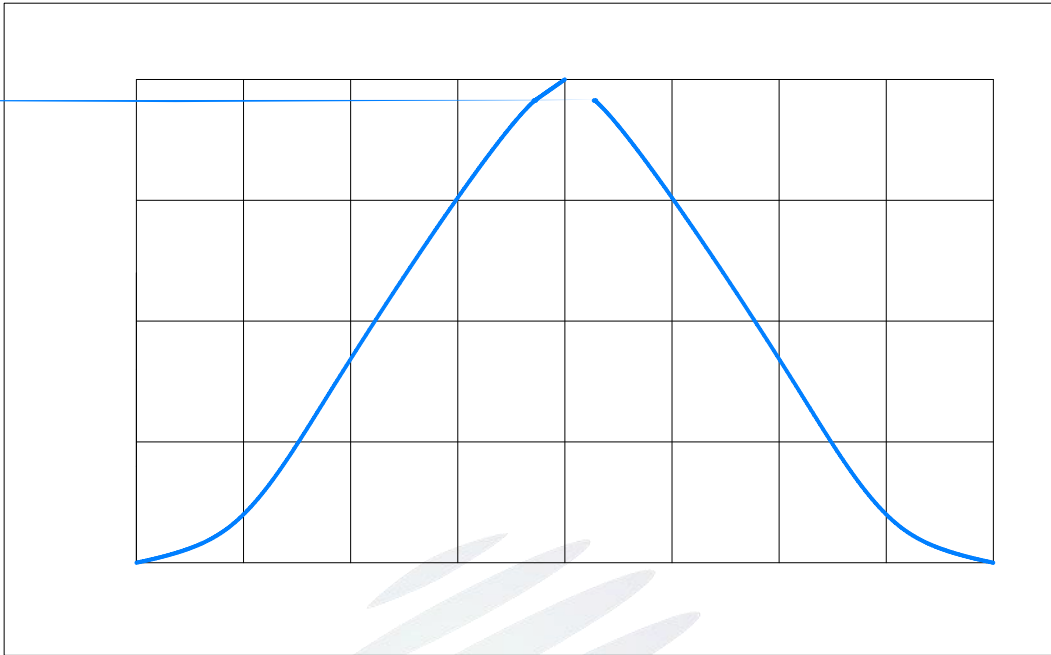

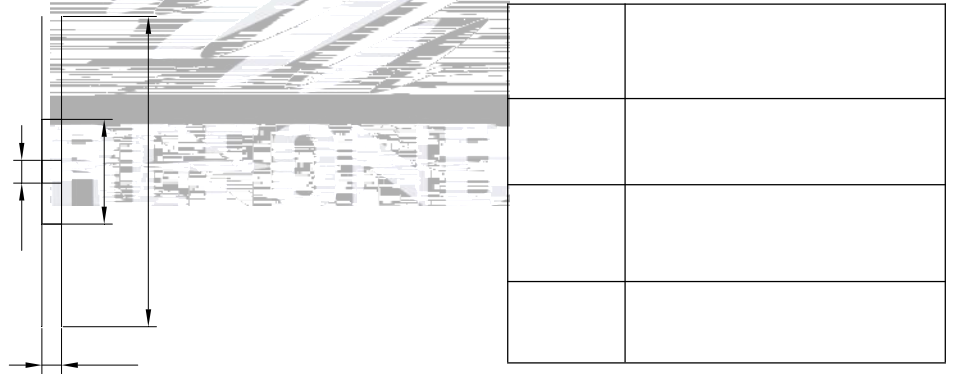
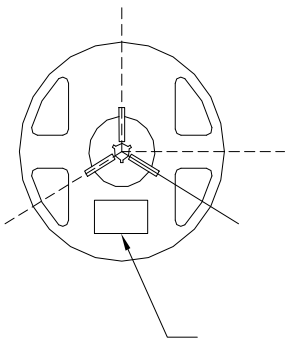
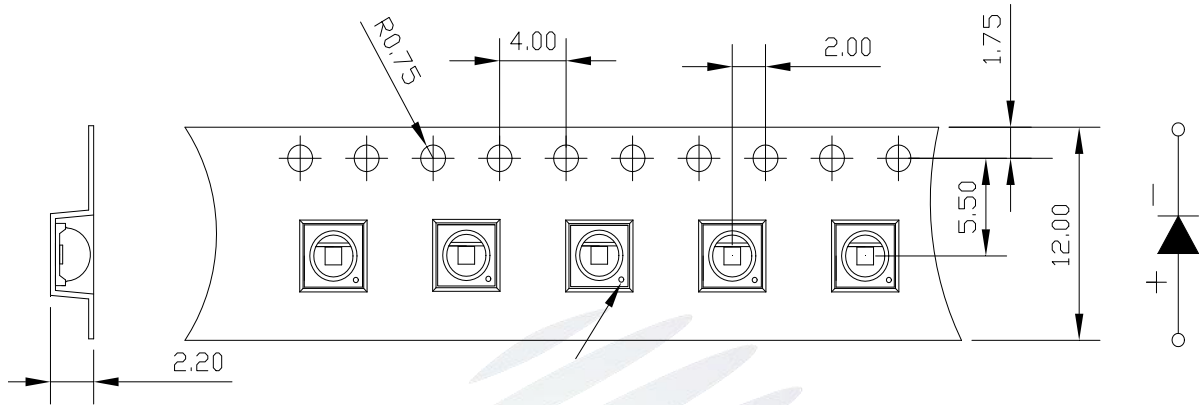

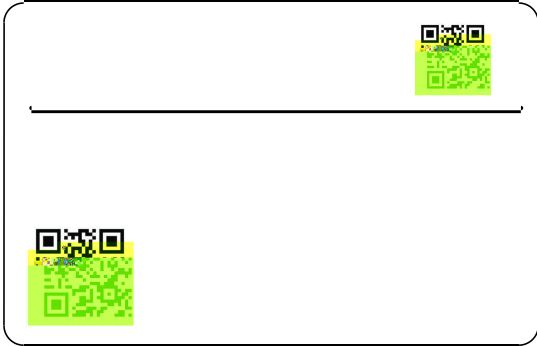

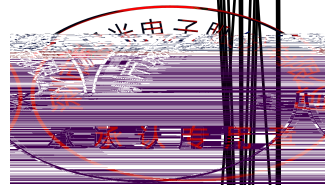
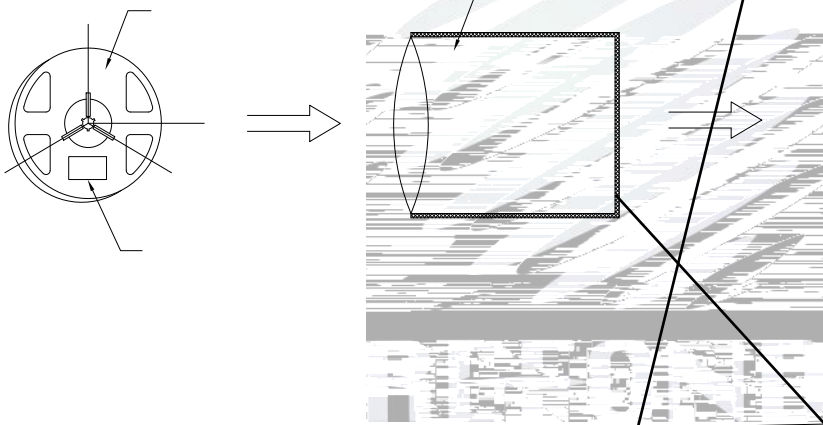

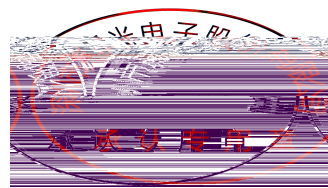
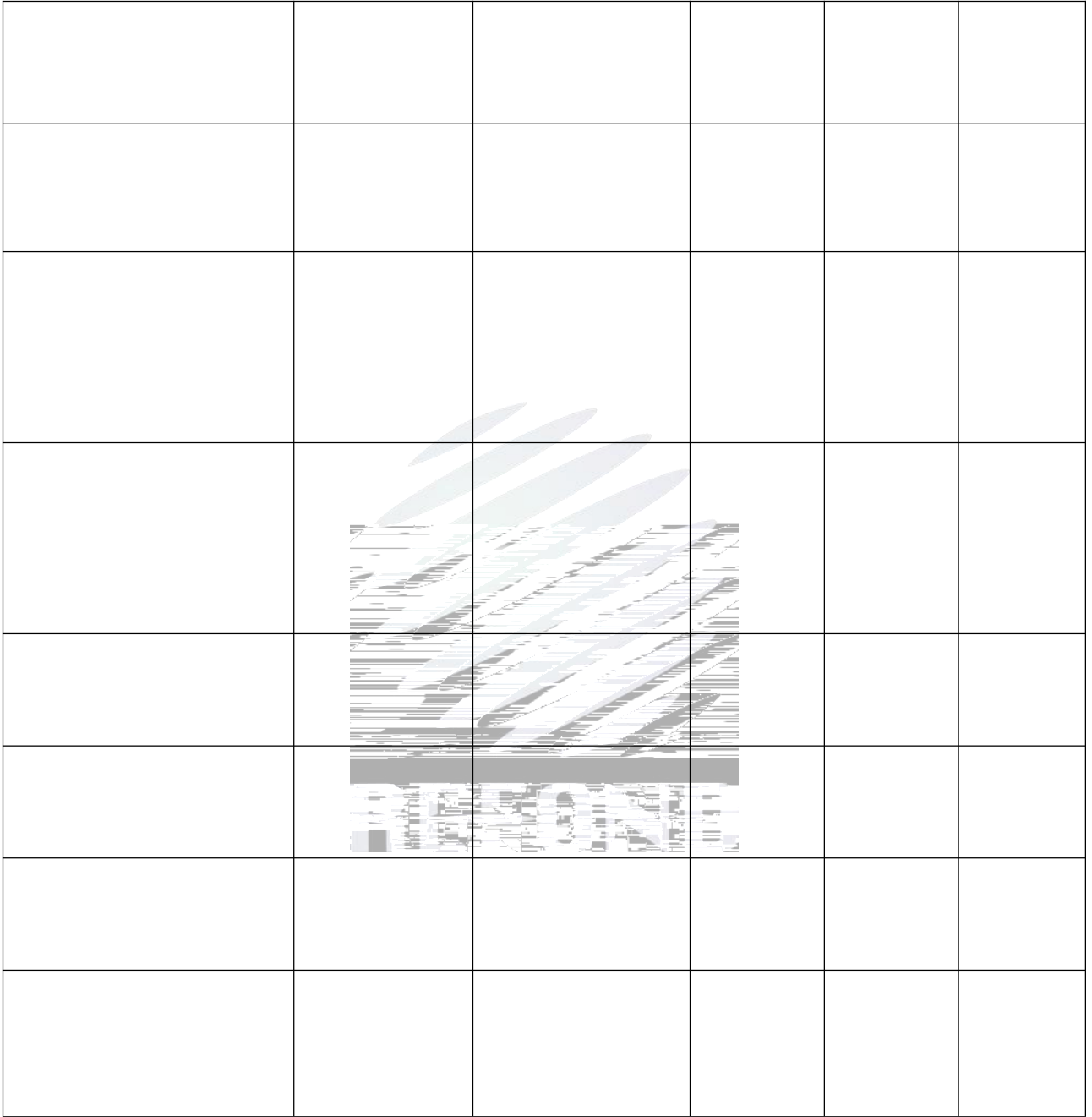



瑞豐光電

REDFUNG OPTOELECTRONICS







瑞豐光電

REUFENG OPTOELECTRONICS

°C

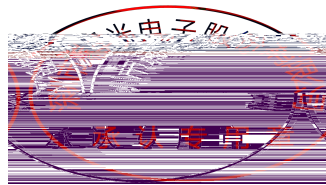

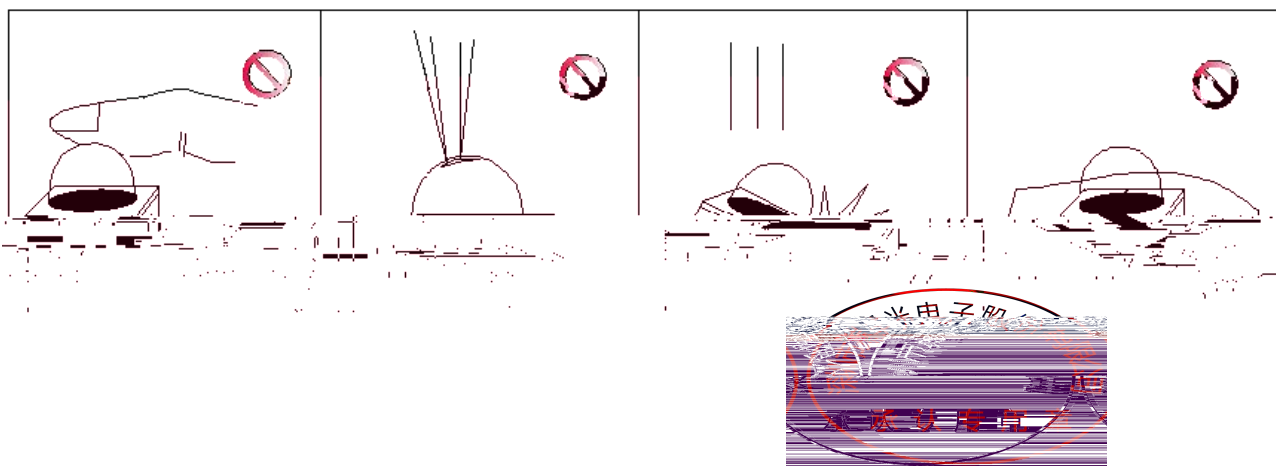



瑞豐光電

REUFENG OPTOELECTRONICS



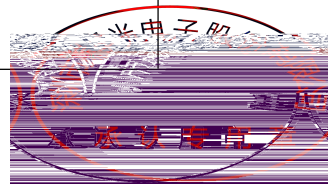



瑞豐光電

REUFENG OPTOELECTRONICS

()

(±) °C

