

# SPECIFICATION

REFOND P/N

RF-OMRL30TS-CG-G

R&D

Mass Production





# 1. Description

## 1.1 General description



The Red source color devices are made with AlGaInp on Substrate Light Emitting Diode .  
 Product Package:3.50mmX2.80mmX3.50mm.

LED

3.50mmX2.80mmX3.50mm.

## 1.2 Features

PLCC4 Package.

extremely narrow angle.

Suitable for all SMT assembly and solder process.

Available on tape and reel.

Moisture sensitivity level: Level 2.

RoHS compliant.      RoHS

Qualifications: The product qualification test plan is based on the guidelines of AEC-Q102  
 Stress Test Qualification for Automotive Grade Discrete Semiconductors

## 1.3 Application

Automotive Lighting Interior and Exterior.



### 1.4 Package Dimension

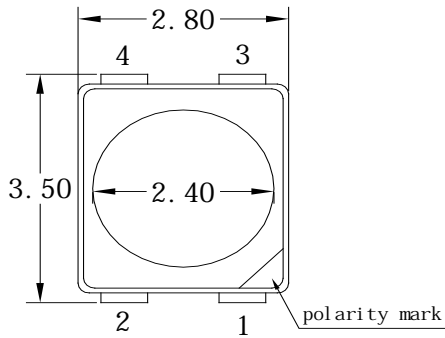

Fig. 1-1 Top View 正面视图

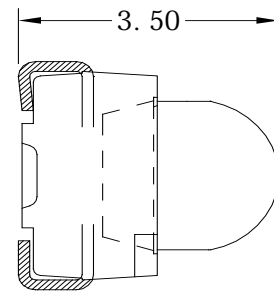

Fig. 1-2 Side View

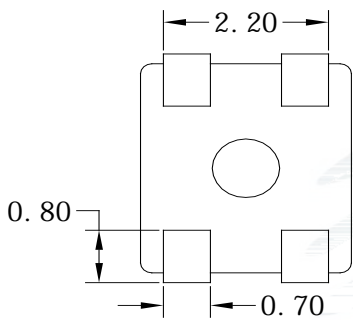

Fig. 1-3 Bottom View

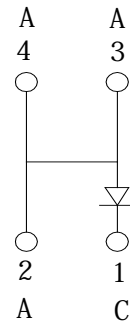

Fig. 1-4 Polarity

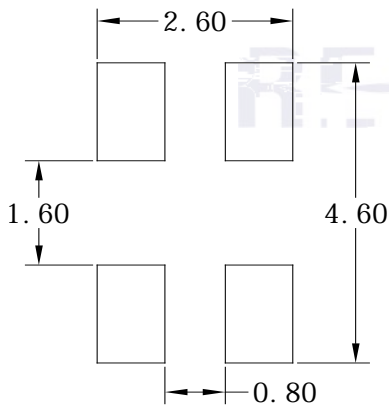

Fig. 1-5 Soldering Patterns

#### Notes

All dimensions units are millimeters.

All dimensions tolerances are  $\pm 0.2\text{mm}$  unless otherwise noted.



## 1.5 Product Parameters

Table 1-1 Electrical / Optical Characteristics at Ts=25°C

Item	Symbol	Test Condition	Value			Unit
			Min.	Typ.	Max.	
Forward Voltage	$V_F$	$I_F=50\text{mA}$	2.0	2.3	2.6	V
Reverse Current	$I_R$	$V_R=5\text{V}$	---	---	10	$\mu\text{A}$
Luminous Intensity	$I_V$	$I_F=50\text{mA}$	15000	21000	35000	mcd
Dominant wavelength	$\lambda_d$	$I_F=50\text{mA}$	617.5	621	625	nm
Viewing Angle		$I_F=50\text{mA}$	---	30	---	deg
Thermal Resistance.	$R_{THJ-S}$	$I_F=50\text{mA}$	---	---	180	K/W

Table 1-2 Absolute Maximum Ratings at Ts=25°C

Parameter	Symbol	Rating	Units
Power Dissipation	$P_D$	182	mW
Forward Current	$I_F$	70	mA
Peak Forward Current	$I_{FP}$	100	mA
Reverse Voltage	$V_R$	5	V
Electrostatic Discharge (HBM)	$E_{SD}$	2000	V
Operating Temperature	$T_{OPR}$	-40 ~ +100	
Storage Temperature			

## Notes

1. 1/10 Duty cycle, 10ms pulse width.
2. The above forward voltage measurement allowance tolerance is  $\pm 0.1V$ .  $\pm 0.1V$ .
3. The above color coordinates measurement allowance tolerance is  $\pm 0.005$ .  $\pm$
4. The above luminous intensity measurement allowance tolerance  $\pm 10\%$ .  $\pm 10\%$ .
5. Care is to be taken that power dissipation does not exceed the absolute maximum rating of the product.
6. All measurements were made under the standardized environment of Refond.
7. When the LEDs are in operation the maximum current should be decided after measuring the package temperature, junction temperature should not exceed the maximum rate. LED
8. ESD yield is over 90% at 2000V ESD (HBM). ESD protection during products handling is needed. 90% LED ESD 000V

### 1.6Bin Range Of Forward Voltage and Luminous Intensity and Dominant wavelength (IF=50mA) BIN (IF=50mA)

Table 1-3

V <sub>F</sub>	C1	C2	D1	D2	E1	E2
	2.0-2.1	2.1-2.2	2.2-2.3	2.3-2.4	2.4-2.5	2.5-2.6
IV mcd	S1	S2	T1	T2		
	15000-18000	18000-23000	23000-28000	28000-35000		
WD(nm)	D2	E1	E2			
	617.5-620	620-622.5	622.5-625			



## 1.7 Typical Optical Characteristics Curves

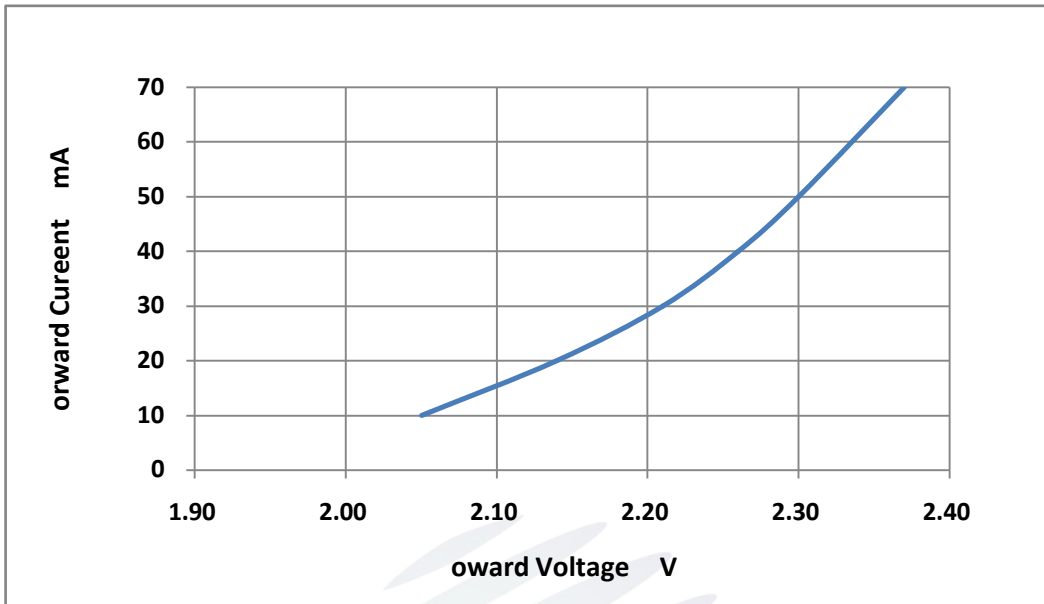

Fig. 1-7 Forward Voltage Vs Forward Current

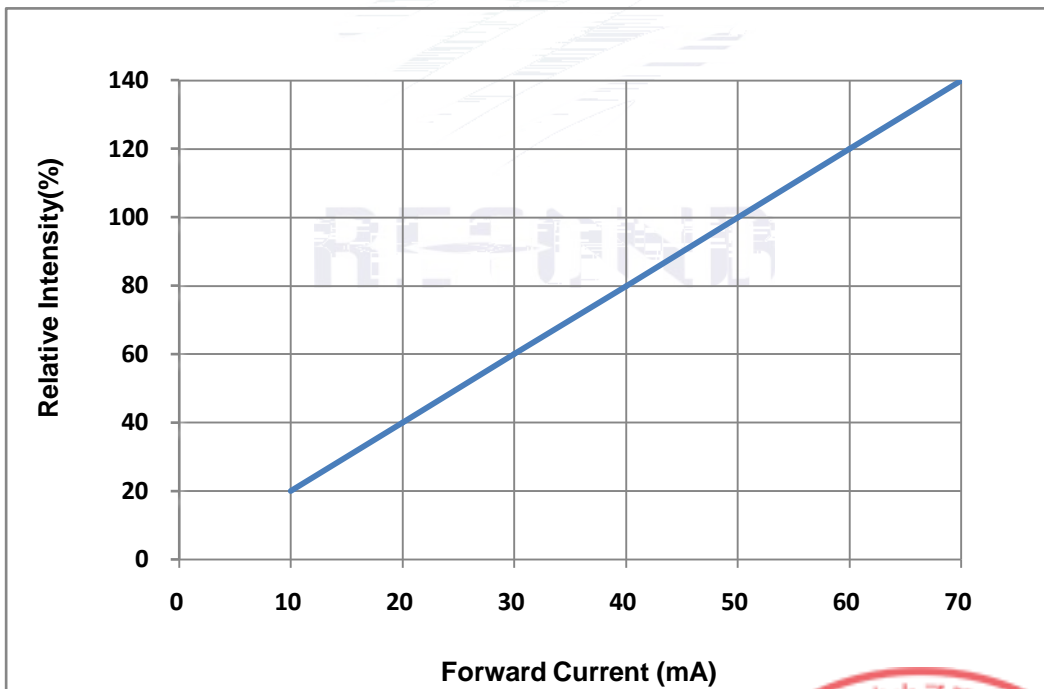

Fig. 1-8 Forward Current Vs Relative Intensity



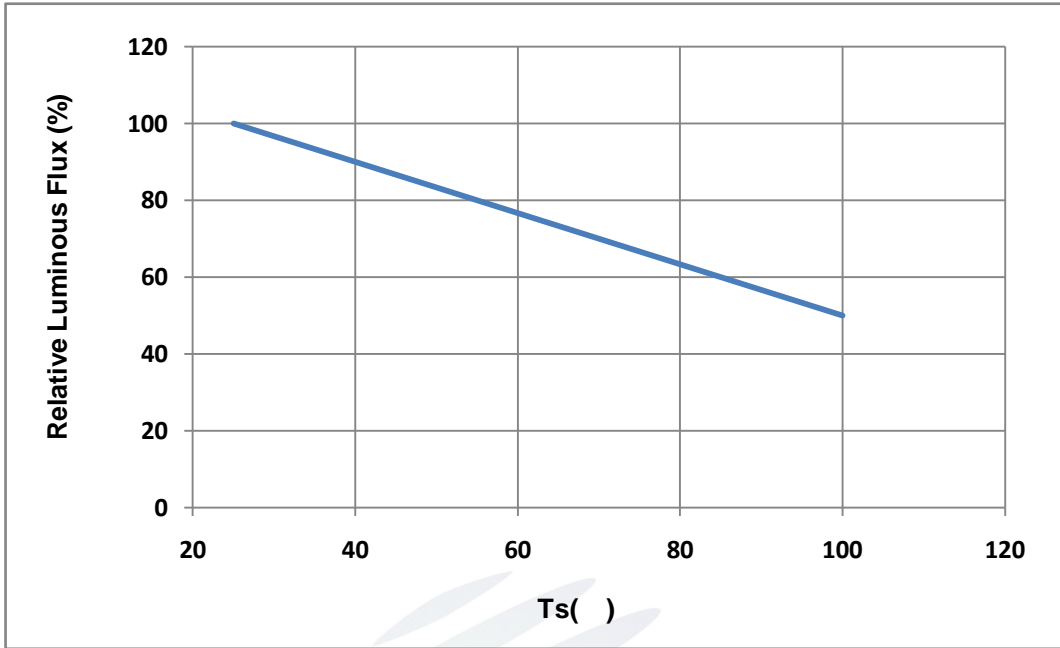

Fig. 1-9 Solder Temperature Vs Relative Intensity

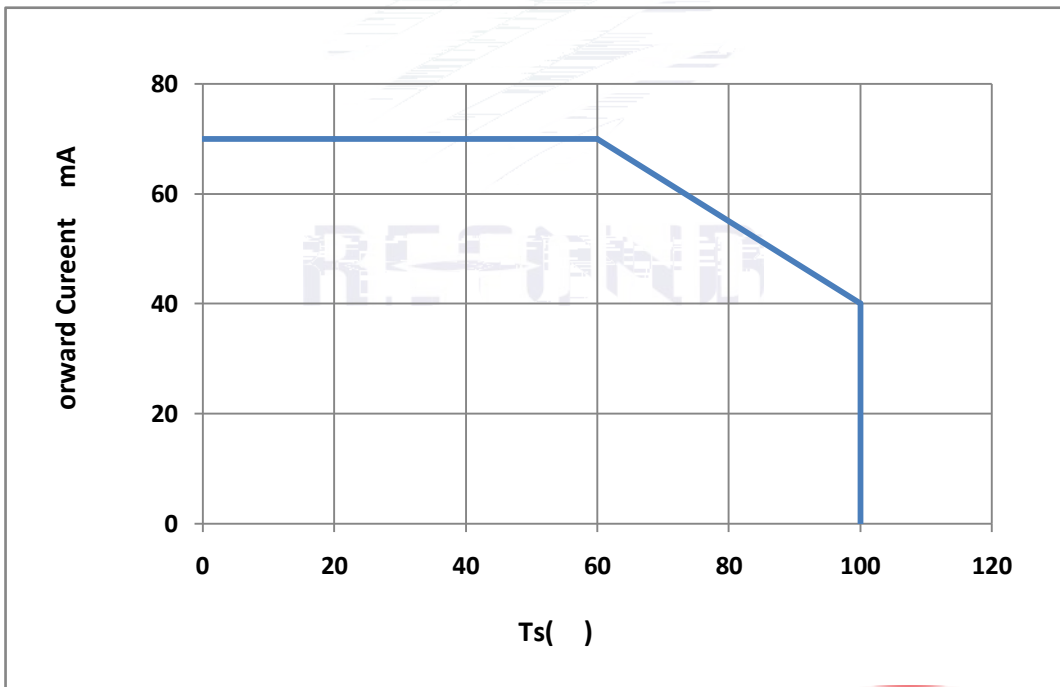

Fig. 1-10 Solder Temperature Vs Forward Current







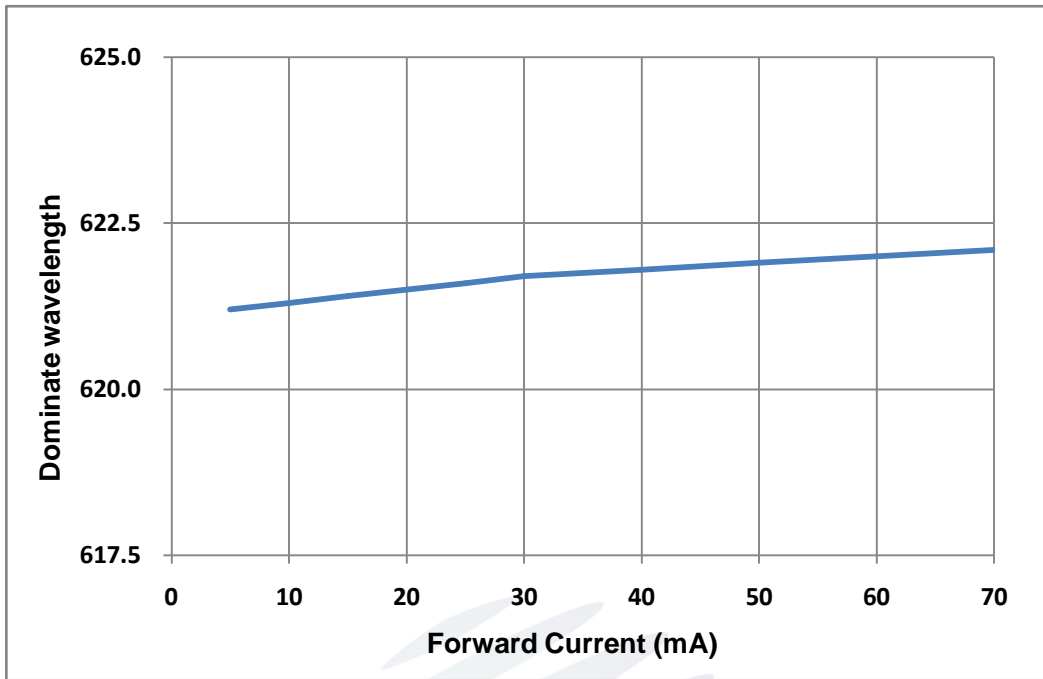

Fig. 1-13 Forward current vs. Dominate wavelength (Ts=25°C)

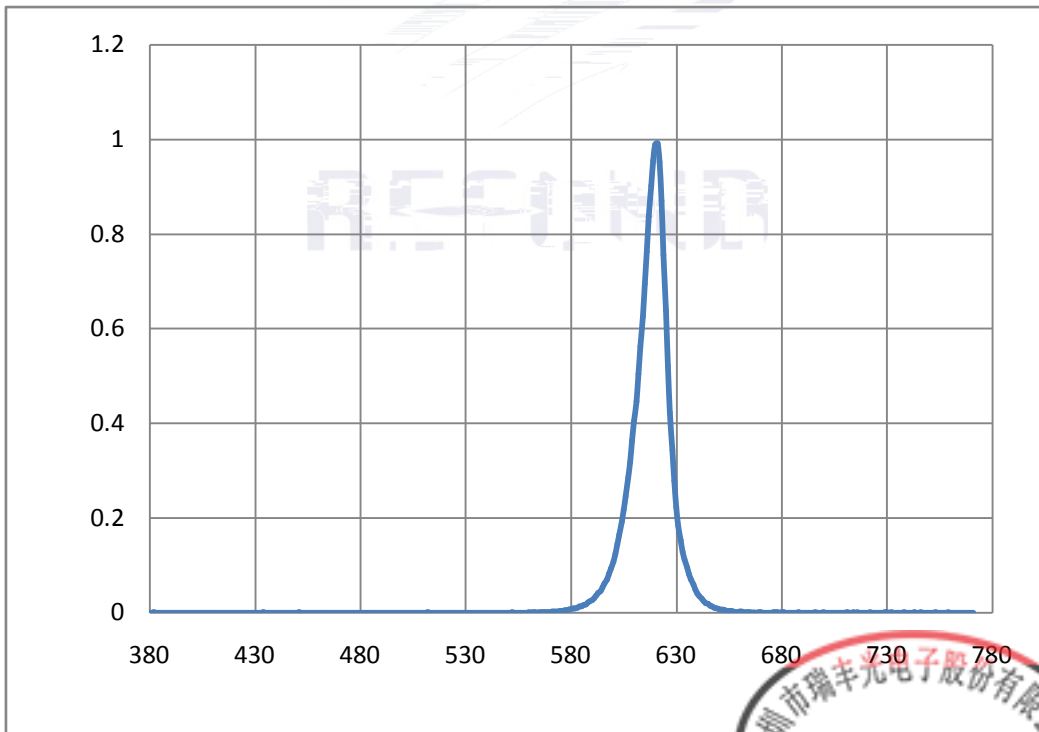

Fig. 1-14 Spectrum Distribution



## 2. Packaging

### 2.1 Packaging Specification

Package:2000pcs/reel.      2000pcs

#### 2.1.1 Carrier Tape Dimension

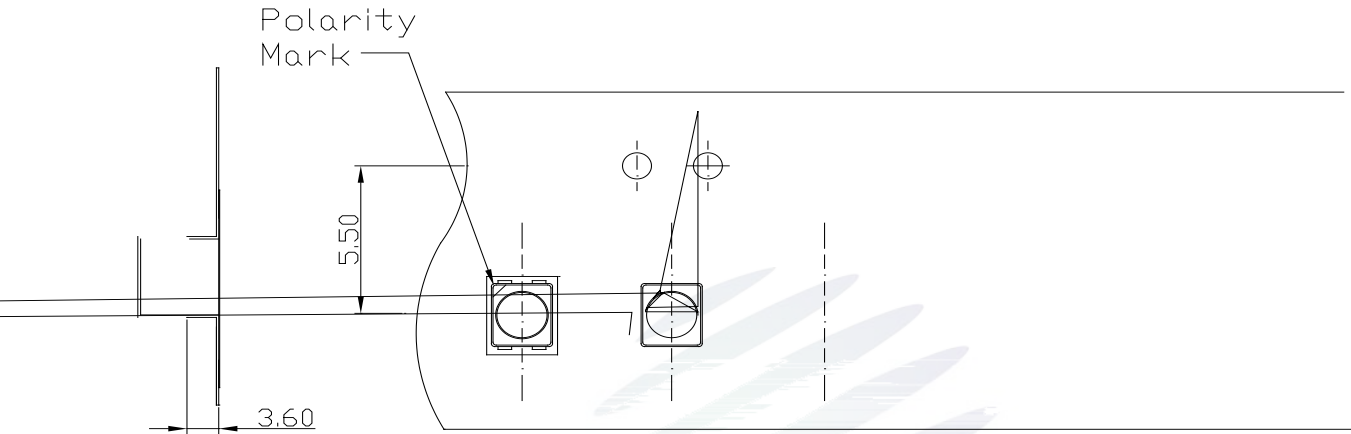

### 2.1.3 Label Form Specification

Table 2 Specification

PART NO.	Part Number
SPEC NO.	Spec Number
LOT NO.	Lot Number
BIN CODE	Bin Code
	Luminous flux

Fig. 2-3 Label

### 2.2 Moisture Resistant Packing

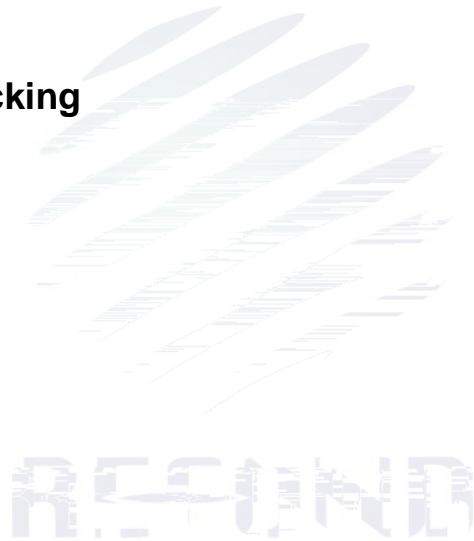

Fig.2-4 Moisture Resistant Packing

### 2.3 Cardboard Box

Fig.2-5 Cardboard Box

## 2.4 Reliability Test Items And Conditions

Table 2-3 Reliability Test Items And Conditions

Test Items	Ref.Standard
------------	--------------



## 2.5 Criteria For Judging Damage

Table 2-4 Criteria For Judging Damage

Test Items	Symbol	Test Condition	Criteria For Judgement	
			Min.	Max.
Forward Voltage	$V_F$	$I_F=50mA$	-	U.S.L*)x1.1
Reverse Current	$I_R$	$V_R = 5V$	-	U.S.L*)x2.0
Luminous Flux		$I_F=50mA$	L.S.L*)x0.7	-

### Notes

- U.S.L: Upper standard level                      L.S.L: Lower standard level
- The above reliability tests is based on the verification of a single/strip LED of Refond's existing experimental platform, the reliability experiment was taken under good heat dissipation conditions. when customers applies the LED to the series and parallel circuit, should take consideration of all the factors such as the current, voltage distribution, heat dissipation and others.                      LED  
LED
- The technical information shown in the data sheets is limited to the typical characteristics and circuit examples of the referenced products. It does not constitute the warranting of industrial property nor the granting of any license.





Notes

(1)Reflow soldering should not be done more than twice. If more than 24 hours between the two solderings ,LED will be damaged. LED

(2)When soldering , do not put stress on the LEDs during heating.

3.1.1 Soldering Iron

(1) When do soldering by hand, keep the temperature of iron below less 300 less than 3 seconds.  
 , 300 3

(2) Soldering by hand should be done only one time.

3.1.2 Repairing

Repairing should not be done after the LEDs have been soldered. When repairing is unavoidable,a double-head soldering iron should be used (as below figure). It should be confirmed in advance whether the characteristics of LEDs will or not be damaged by repairing.

LED

LED

3.1.3 Cautions

(1) The encapsulated material of the LEDs is silicone. Therefore the LEDs have a soft surface on the top of package. The pressure to the top surface will be impacted on the reliability of the LEDs. Precautions should be taken to avoid the strong pressure on the encapsulated part. So when use the picking up nozzle, the pressure on the silicone resin should be proper. LED LED

(2) Components should not be mounted on warped (non coplanar) portion of PCB. After soldering, do not warp the circuit board.LED PCB

(3) Do not apply mechanical force or excess vibration during the cooling process to normal temperature after soldering. Do not rapidly cool device after soldering.





## 4. Handling Precautions

### 4.1 Handling Precautions

(1) LED operating environment and sulfur element composition cannot be over 100PPM in the LED mating usage material. This is provided for informational purposes only and is not a warranty or endorsement.

LED 100PPM.

(2) In order to prevent external material from getting into the inside of LED, which may cause the malfunction of LED, the single content of Bromine element is required to be less than 900PPM, the single content of Chlorine element is required to be less than 900PPM, the total content of Bromine element and Chlorine element in the external materials of the application products is required to be less than 1500PPM. This is provided for informational purposes only and is not a warranty or endorsement.

	LED	LED
	900PPM	900PPM
1500PPM.		

(3) VOCs (Volatile organic compounds) emitted from materials used in the construction of fixtures can penetrate silicone encapsulants of LEDs and discolor when exposed to heat and photonic energy. The result can be a significant loss of light output from the fixture. Knowledge of the properties of the materials selected to be used in the construction of fixtures can help prevent these issues. Refond advises against the use of any chemicals or materials that have been found or are suspected to have an adverse affect on device performance or reliability. To verify compatibility,



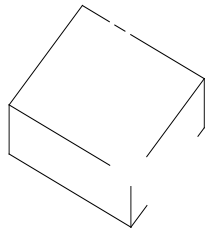

Fig 4-1 Handling Precautions

(5) In designing a circuit, the current through each LED can not exceed the absolute maximum rating specified for each LED. In the mean while, resistors for protection should be applied, other wise slight voltage shift will cause big current change, burn out may happen. The driving circuit must be designed to allow forward voltage only when it is ON or OFF. If the reverse voltage is applied to LED, migration can be generated resulting in LED damage.

LED

LED

(6) Thermal Design is paramount importance because heat generation may result in the Characteristics decline, such as brightness decreased, Color change and so on. Please consider the heat generation of the LEDs when making the system design.

LED

(7) Compared to standard encapsulants, silicone is generally softer, and the surface is more likely to attract dust, requiring special care during processing. In cases where a minimal level of dirt and dust particles cannot be guaranteed, a suitable cleaning solution must be applied to the surface after the soldering of components. Refond suggests using isopropyl alcohol for cleaning. In case other solvents are used, it must be assured that these solvents do not dissolve the package or resin. Ultrasonic cleaning is not recommended. Ultrasonic cleaning may cause damage to the LED.

LED



## Version History/

Date	Revisor	Version	Verifier	Remarks
	Chao Daijian		Zhang Shiming	New issue
	Li Xianhui		Zhang Shiming	Template update
	Li Xianhui		hu iming	Template update
2022/07/13	Li Xianhui		hu iming	Template update
				



REFOND



Declare

This specification is written both in English and in Chinese and the latter is formal.