

# SPECIFICATION

REFOND P/N

RF-A14N-YDE-H23

R&D

Mass Production



## Contents

1. Description	3
1.1 General Description	3
1.2 Features	3
1.3 Application	3
1.4 Package Dimension	4
1.5 Product Parameters	5
1.6 Bin Range Of Forward Voltage and Luminous Intensity and Dominant wavelength (IF=20mA)	
BIN (IF=20mA)	6
1.7 Typical Optical Characteristics Curves	7
2. Packaging	11
2.1 Packaging Specification	11
2.1.1 Carrier Tape Dimension	11
2.1.2 Reel Dimension	11
2.1.3 Label Form Specification	12
2.2 Moisture Resistant Packing	12
2.3 Cardboard Box	12
2.4 Reliability Test Items And Conditions	13
2.5 Criteria For Judging Damage	14
3. SMT Reflow Soldering Instructions SMT	15
3.1 SMT Reflow Soldering Instructions SMT	15
4. Handling Precautions	17
4.1 Handling Precautions	17



# 1. Description

## 1.1 General Description



The Yellow source color devices are made with AlGaInP on Substrate Light Emitting Diode  
 Product Package: 2.2mmX1.4mmX1.3mm.

LED AlGaInP

2.2mmX1.4mmX1.3mm

## 1.2 Features

PLCC2 Package. PLCC2

Extremely wide viewing angle.

Suitable for all SMT assembly and solder process. SMT

Available on tape and reel.

Moisture sensitivity level: Level 2. Level2

Compliance with RoHS and REACH. RoHS REACH

Qualifications: The product qualification test plan is based on the guidelines of AEC-Q101  
 Stress Test Qualification for Automotive Grade Discrete Semiconductors

AEC-Q101

## 1.3 Application

Automotive Lighting Interior.





## 1.5 Product Parameters

Table 1-1 Electrical / Optical Characteristics at Ts=25°C

Item	Symbol	Test Condition	Value			Unit
			Min.	Typ.	Max.	
Forward Voltage	$V_F$	$I_F=20\text{mA}$	1.8	2.0	2.4	V
Reverse Current	$I_R$	$V_R=5\text{V}$	---	---	10	$\mu\text{A}$
Luminous Intensity	$I_V$	$I_F=20\text{mA}$	230	320	430	mcd
Dominant wavelength	WD	$I_F=20\text{mA}$	585	587.5	595	nm
Viewing Angle		$I_F=20\text{mA}$	---	120	---	deg
Thermal Resistance.	$R_{THJ-S}$	$I_F=20\text{mA}$	---	---	300	$^{\circ}\text{C}/\text{W}$

Table 1-2 Absolute Maximum Ratings at Ts=25°C



## Notes

1. 1/10 Duty cycle, 10ms pulse width. 10ms, 1/10.
2. The above forward voltage measurement allowance tolerance is  $\pm 0.1V$ .  $\pm 0.1V$ .
3. The above color coordinates measurement allowance tolerance is  $\pm 0.005$ .  $\pm 0.005$ .
4. The above luminous intensity measurement allowance tolerance  $\pm 10\%$ .  $\pm 10\%$ .
5. Care is to be taken that power dissipation does not exceed the absolute maximum rating of the product.
6. All measurements were made under the standardized environment of Refond.
7. When the LEDs are in operation the maximum current should be decided after measuring the package temperature, junction temperature should not exceed the maximum rate. LED
8. ESD yield is over 90% at 2000V ESD (HBM). ESD protection during products handling is needed. 90% LED ESD2000V ,

## 1.6

## 1.7 Typical Optical Characteristics Curves

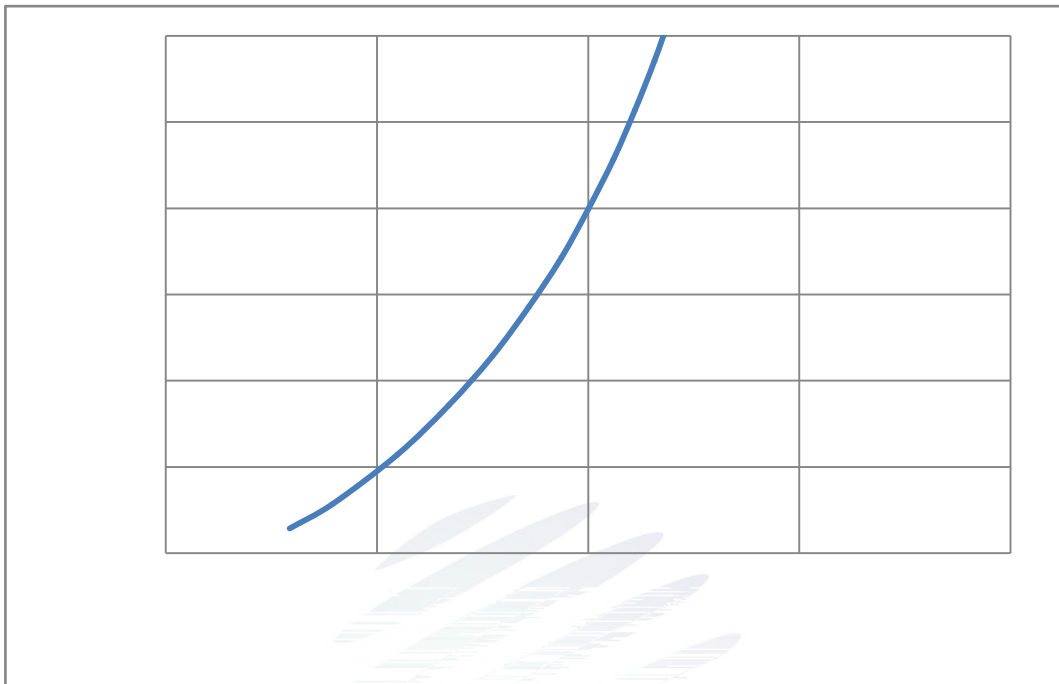
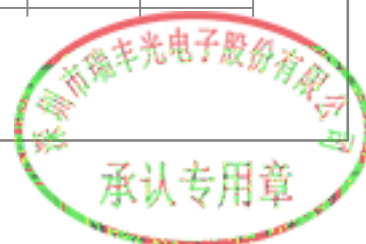

Fig. 1-6 Forward Voltage Vs Forward Current



Fig. 1-7 Forward Current Vs Relative Intensity



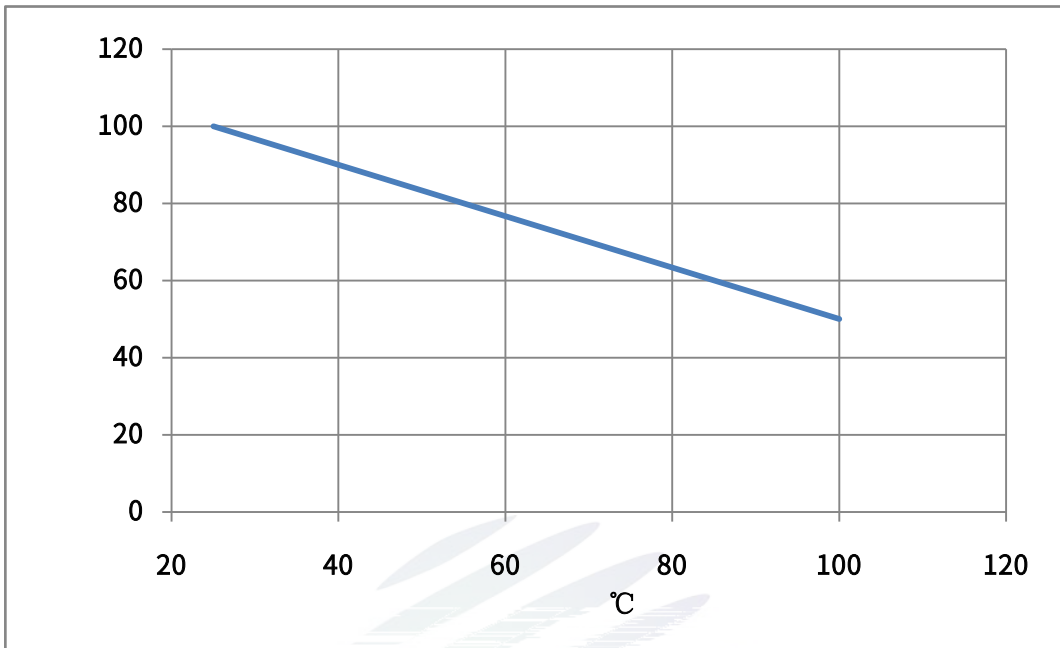

Fig. 1-8 Solder Temperature Vs Relative Intensity

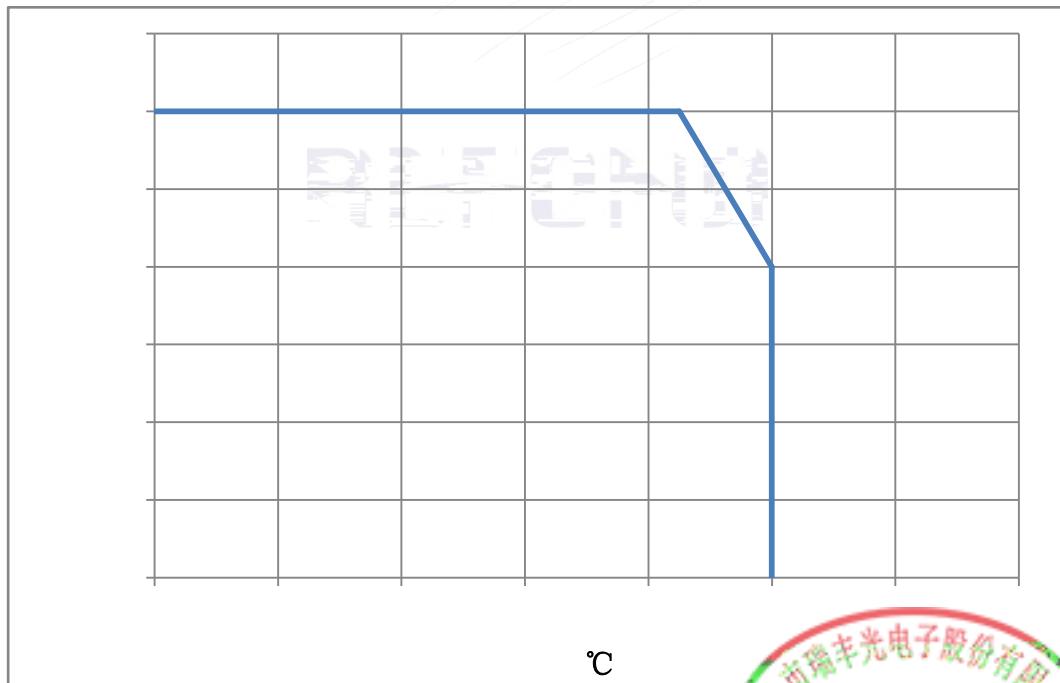
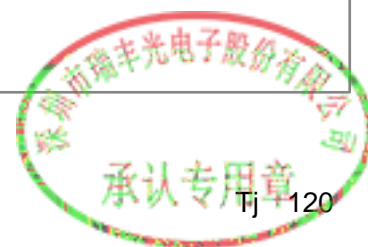

Fig. 1-9 Solder Temperature Vs Forward Current



Tj 120



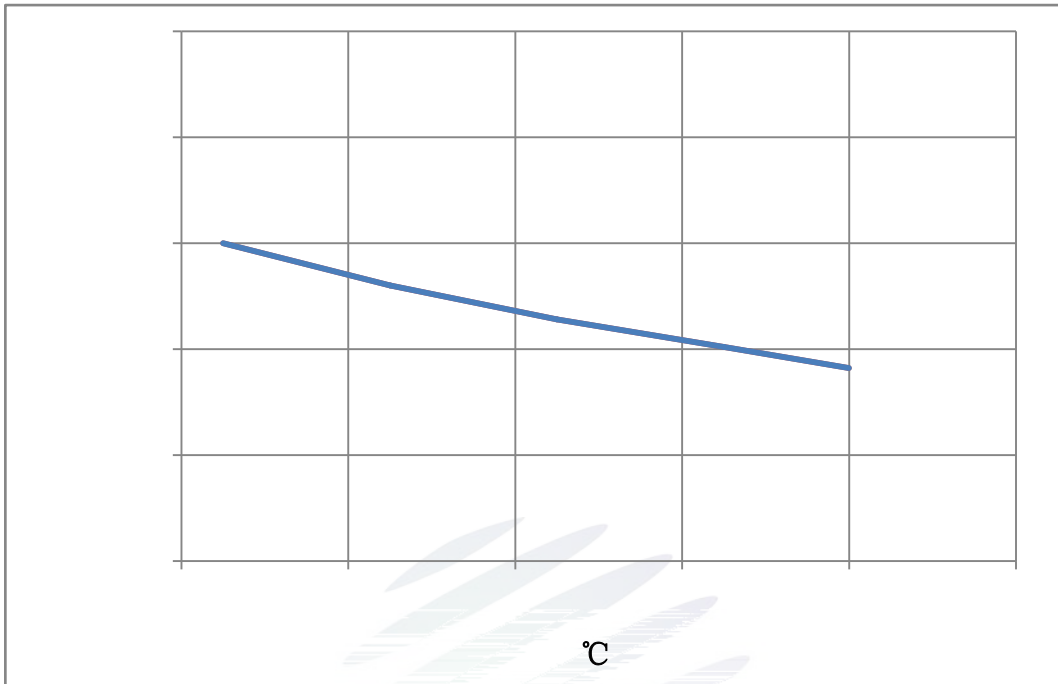

Fig. 1-10 Forward Voltage Vs Solder Temperature

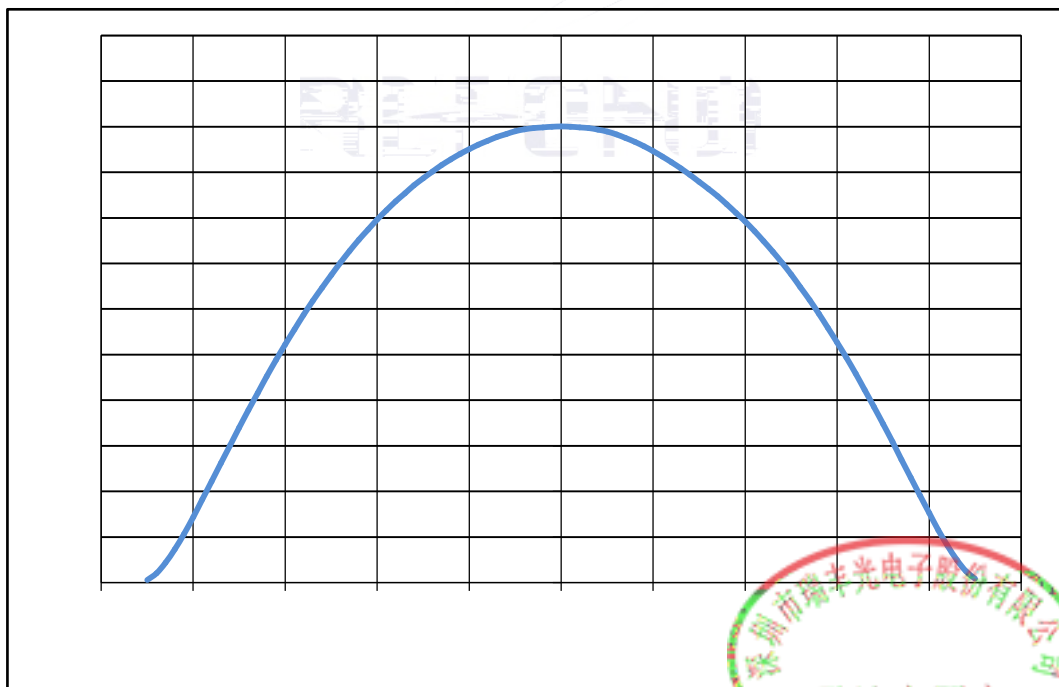

Fig. 1-11 Radiation diagram

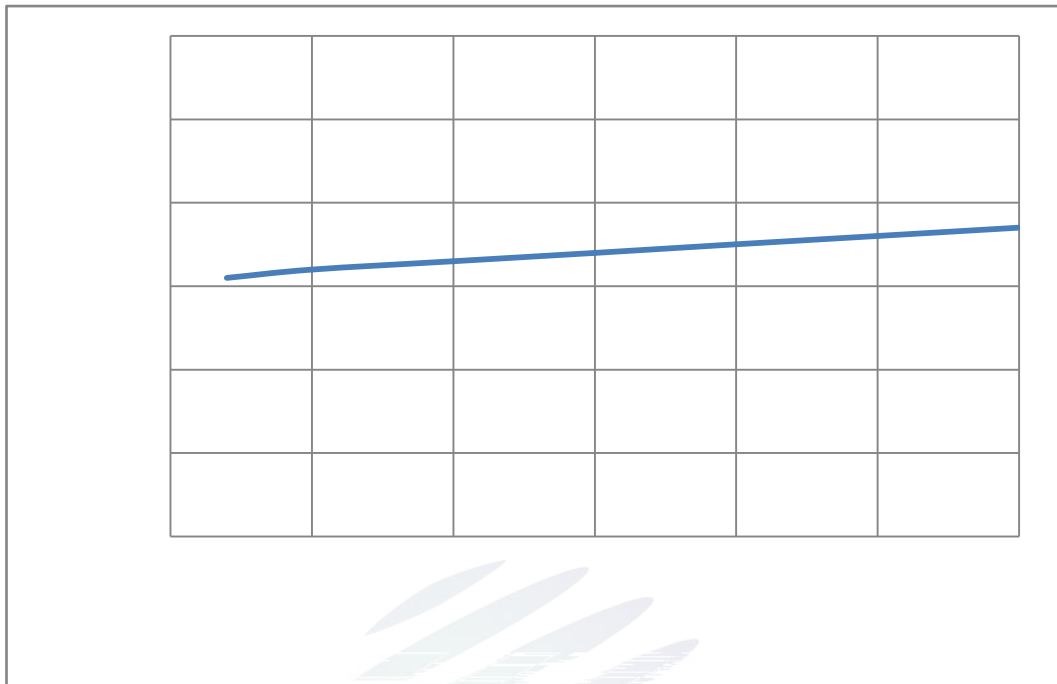

Fig. 1-12 Forward current VS Dominate wavelength (Ts=25°C)

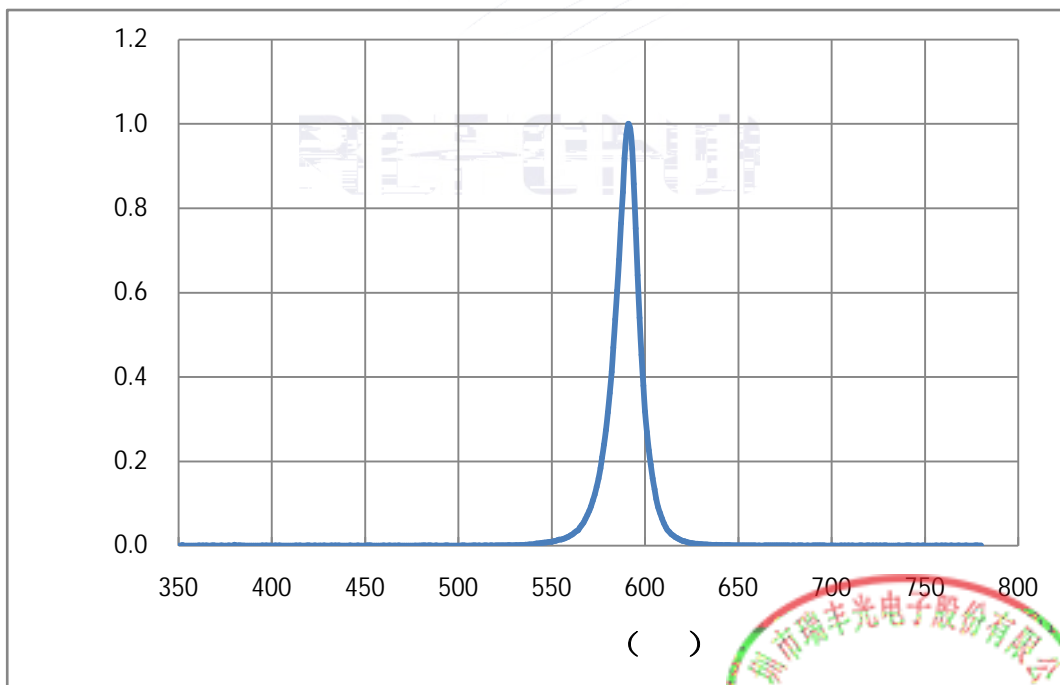
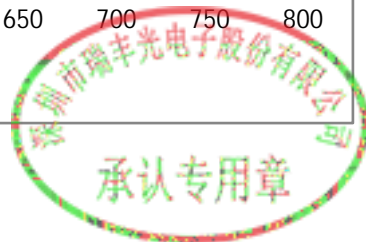

Fig. 1-13 Spectrum Distribution



## 2. Packaging

### 2.1 Packaging Specification

Package:3000pcs/reel. 3000pcs

#### 2.1.1 Carrier Tape Dimension



Fig.2-1 Carrier Tape Dimension

#### 2.1.2 Reel Dimension

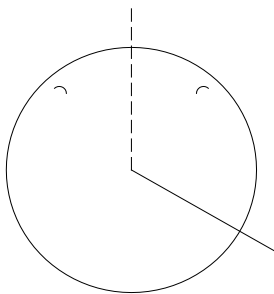

Fig.2-2 Reel Dimension

Table 2-1 Reel Dimension

A	8.0± 0.1mm
B	178.0± 1.0mm
C	60.0± 1.0mm
D	13.0± 0.5mm

#### Notes

The tolerances unless mentioned  $\pm 0.1$ mm. Unit : mm  $\pm 0.1$

### 2.1.3 Label Form Specification

Table 2-2 Specification

PART NO.	Part Number
SPEC NO.	Spec Number
LOT NO.	Lot Number
BIN CODE	Bin Code
IV	Luminous Intensity
XY	Chromaticity Bin
V <sub>F</sub>	Forward Voltage
WLD	Wavelength
QTY	Packing Quantity
DATE	Made Date

Fig. 2-3 Label Form Specification

### 2.2 Moisture Resistant Packing

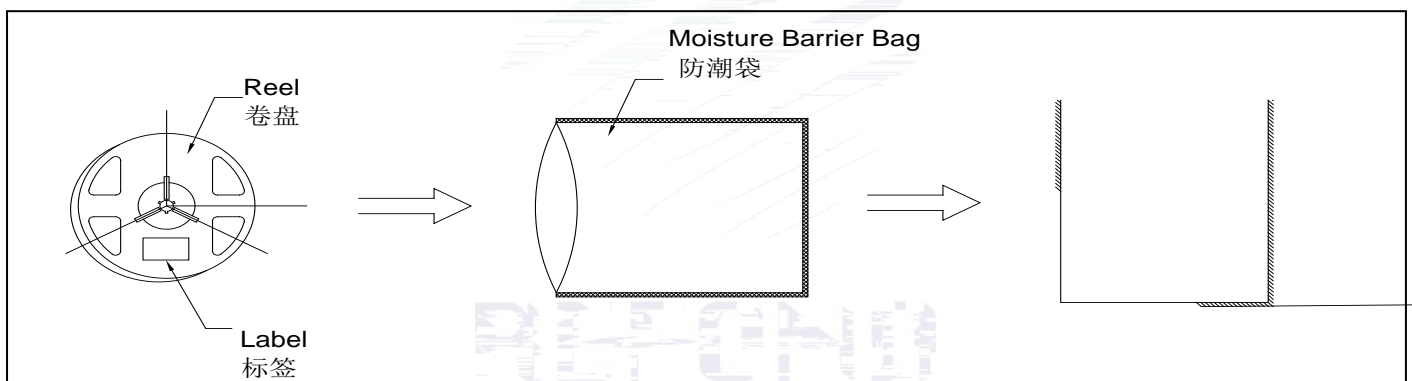

Fig.2-4 Moisture Resistant Packing

### 2.3 Cardboard Box



Fig.2-5 Cardboard Box

## 2.4 Reliability Test Items And Conditions

Table 2-3 Reliability Test Items And Conditions

Test





### 3.SMTReflow Soldering Instructions SMT

#### 3.1SMT Reflow Soldering Instructions SMT

Fig.3-1SMT Reflow Soldering Instructions SMT

Table 3-1Reflow parameters

Average temperature

REFOND

Notes

(1)Reflow soldering should not be done more than twice. If more than 24 hours between the two soldering,LED will be damaged. 24 LED

no Tw-162) -0.3 0.001 T29Tj),0Dw 8,,234 A 0t2504pTc -0F[E45822>114C56F—002505D28>7692B0.00A3585(1D036510AF1006





## 4. Handling Precautions

### 4.1 Handling Precautions

(1) LED operating environment and sulfur element composition cannot be over 100PPM in the LED mating usage material. This is provided for informational purposes only and is not a warranty or endorsement.

LED 100PPM

(2) In order to prevent ex-ternal material from getting into the inside of LED, which may cause the malfunction of LED, the single content of Bromine element is required to be less than 900PPM,the single content of Chlorine element is required to be less than 900PPM,the total content of Bromine element and Chlorine element in the external materials of the application products is required to be less than 1500PPM. This is provided for informational purposes only and is not a warranty or endorsement.

LED 900PPM 900PPM 1500PPM

(3) VOCs (Volatile organic compounds) emitted from materials used in the construction of fixtures can penetrate silicone encapsulants of LEDs and discolor when exposed to heat and photonic energy. The result can be a significant loss of light output from the fixture. Knowledge of the properties of the materials selected to be used in the construction of fixtures can help prevent these issues. Refond advises against the use of any chemicals or materials that have been found or are suspected to have an adverse affect on device performance or reliability. To verify compatibility, Refond recommends that all chemicals and materials be tested in the specific application and environment for which they are intended to be used. Attaching LEDs, do not use adhesives that outgas organic vapor.

LED LED

LED

(4) Handle the component along the side surface by using forceps or appropriate tools; Do not directly touch or Handle the silicone lens surface, it may damage the internal circuitry.



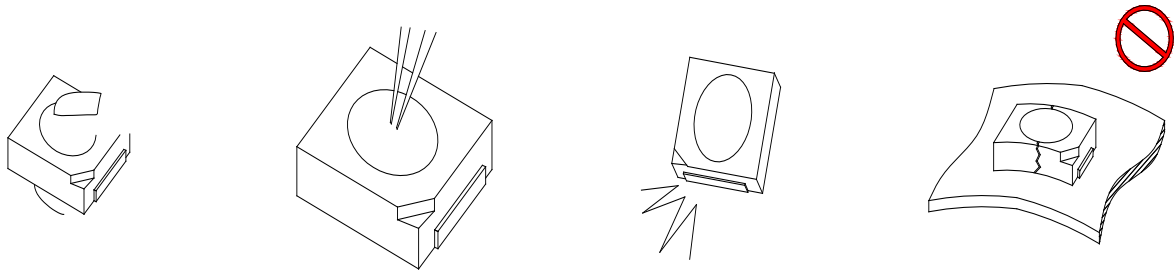

Fig 4-1 Handling Precautions

(5) In designing a circuit, the current through each LED can not exceed the absolute maximum rating specified for each LED. In the meanwhile, resistors for protection should be applied, otherwise slight voltage shift will cause big current change, burn out may happen. The driving circuit must be designed to allow forward voltage only when it is ON or OFF. If the reverse voltage is applied to LED, migration can be generated resulting in LED damage.

LED

LED

(6) Thermal Design is paramount importance because heat generation may result in the Characteristics decline, such as brightness decreased, Color change and so on. Please consider the heat generation of the LEDs when making the system design.

LED

(7) Compared to standard encapsulants, silicone is generally softer, and the surface is more likely to attract dust, requiring special care during processing. In cases where a minimal level of dirt and dust particles cannot be guaranteed, a suitable cleaning solution must be applied to the surface after the soldering of components. Refond suggests using isopropyl alcohol for cleaning. In case other solvents are used, it must be assured that these solvents do not dissolve the package or resin. Ultrasonic cleaning is not recommended. Ultrasonic cleaning may cause damage to the LED.

LED

Table 4-1 Storage

Conditions		Temperature	Humidity	Time
Storage	Before Opening Aluminum Bag	30	75%	Within 1 Year From Date
	After Opening			



Date





Declare

This specification is written both in English and in Chinese and the latter is formal.