

# SPECIFICATION

REFOND P/N

RF-A1F30-W1FN-B1

R&D

Mass Production



## Contents

1. Description .....	3
1.1 General Description .....	3
1.2 Features .....	3
1.3 Application .....	3
1.4 Package Dimension .....	4
1.6 Bin Range Of Forward Voltage and Luminous Flux (IF=80mA) .....	6
BIN	
(IF=80mA).....	6
1.7 Typical Optical Characteristics Curves .....	8
2. Packaging .....	12
2.1 Packaging Specification .....	12
2.1.1 Carrier Tape Dimension .....	12
mm	
2.1.2 Reel Dimension .....	12
2.1.3 Label Form Specification .....	13
2.2 Moisture Resistant Packing .....	13
2.3 Cardboard Box .....	13
2.4 Reliability Test Items And Conditions .....	14
2.5 Criteria For Judging Damage .....	15
3. SMT Reflow Soldering Instructions SMT .....	16
3.1 SMT Reflow Soldering Instructions SMT .....	16
4. Handling Precautions .....	18
4.1 Handling Precautions .....	18



## 1. Description

### 1.1 General Description

The White LED, which was fabricated by using a blue chip and the phosphor.

Product Package: 3.00mmX1.40mmX0.52mm.

LED

3.00mmX1.40mmX0.52mm

### 1.2 Features

EMC Package. EMC

Extremely wide viewing angle.

Suitable for all SMT assembly and solder process.

SMT

Available on tape and reel.

Moisture sensitivity level: Level 2.

### 1.4 Package Dimension

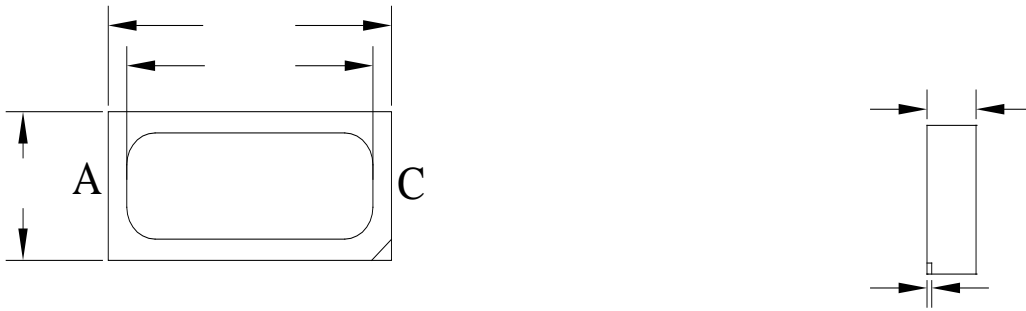
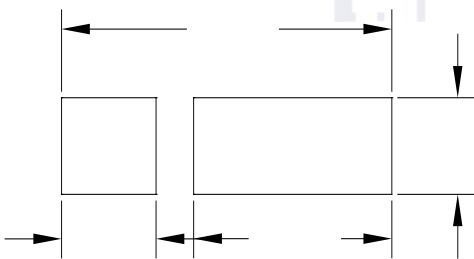

Fig. 1-1 Top View正面视图



Notes

1. All dimensions units are millimeters.
2. All dimensions tolerances are  $\pm 0.2\text{mm}$  unless otherwise noted.



..0.2

## 1.5 Product Parameters

Table 1-1 Electrical / Optical Characteristics at Ts=25°C

Item	Symbol	Test Condition	Value			Unit
			Min.	Typ.	Max.	
Forward Voltage	$V_F$	$I_F=80\text{mA}$	2.8	2.9	3.4	V
Reverse Current	$I_R$	$V_R=5\text{V}$	---	---	10	$\mu\text{A}$
Luminous Flux		$I_F=80\text{mA}$	26.8	---	39.8	lm
Viewing Angle		$I_F=80\text{mA}$	---	120	---	deg
Thermal Resistance.	$R_{THJ-S}$	$I_F=80\text{mA}$	---	---	50	/W

Table 1-2 Absolute Maximum Ratings at Ts=25°C

Parameter	Symbol	Rating	Units
Power Dissipation	$P_D$	680	mW
Forward Current	$I_F$	200	mA
Peak Forward Current	$I_{FP}$	350	mA
Reverse Voltage	$V_R$	5	V
Electrostatic Discharge (HBM)	$E_{SD}$	8000	V
Operating Temperature	$T_{OPR}$	-40 ~ +110	
Storage Temperature	T	-40 ~ +110	
Junction Temperature	$T_J$	125	

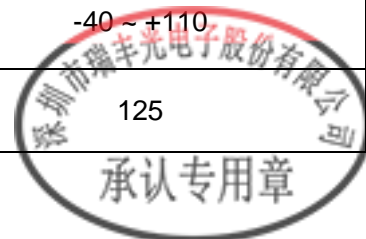

Notes

1. 1/10 Duty cycle, 10ms pulse width. 10ms, 1/10.
2. The above forward voltage measurement allowance tolerance is  $\pm 0.1V$ . ...: %M%
3. The above color coordinates measurement allowance tolerance is  $\pm 0.005$ . ...0.005.
4. The above luminous intensity measurement allowance tolerance  $\pm 10\%$ . ...(' fl %
5. Care is to be taken that power dissipation does not exceed the absolute maximum rating of the product.
6. All measurements were made under the standardized environment of Refond.
7. When the LEDs are in operation the maximum current should be decided after measuring the package temperature, junction temperature should not exceed the maximum rate. LED
8. ESD yield is over 90% at 8000V ESD (HBM). ESD protection during products handling is needed. O' fl LED  
ESD8000M ,

## 1.6 Bin Range Of Forward Voltage and Luminous Flux (IF=80mA)

### BIN (IF=80mA)

Table 1-3

V <sub>F</sub> V	V2	V3	V4	V5	V6	V7
	2.8-2.9	2.9-3.0	3.0-3.1	3.1-3.2	3.2-3.3	3.3-3.4
	8P	9P	6Q	7Q	8Q	9Q
	26.8-28.7	28.7-30.6	30.6-32.7	32.7-34.8	34.8-37.3	37.3-39.8



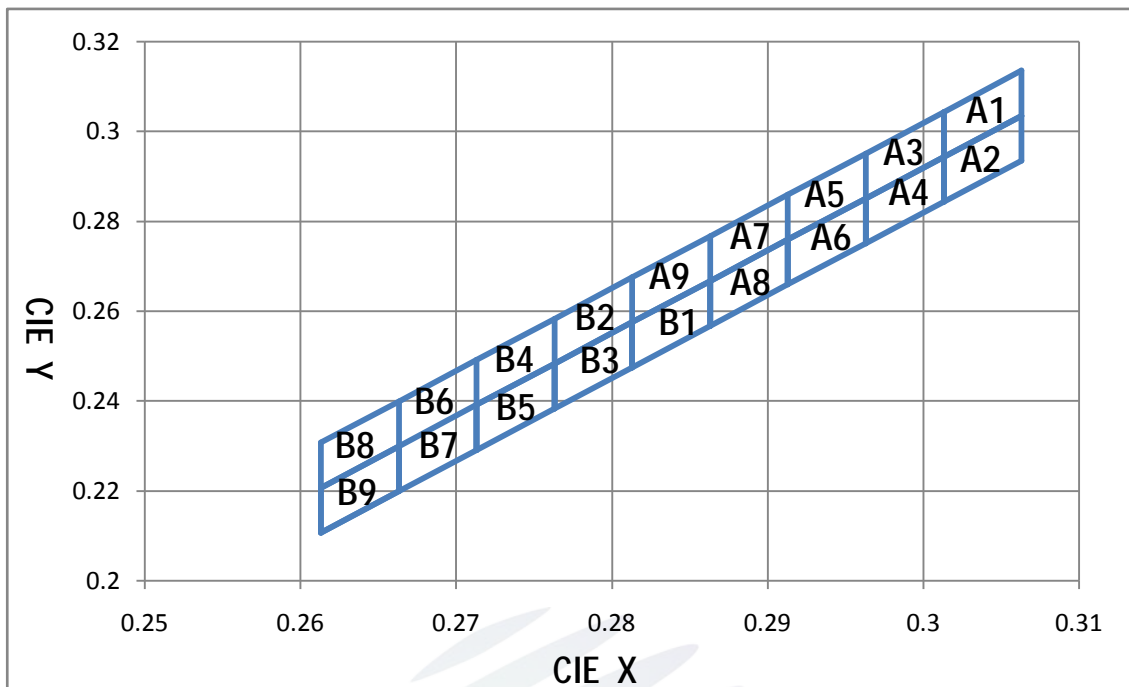

Fig. 1-6 The C.I.E Chromaticity Diagram CIE

Table 1-4

BIN CODE	CIE-X1	CIE-Y1	CIE-X2	CIE-Y2	CIE-X3	CIE-Y3	CIE-X4	CIE-Y4
A1	0.3013	0.2943	0.3013	0.3043	0.3063	0.3135	0.3063	0.3035
A2	0.3013	0.2843	0.3013	0.2943	0.3063	0.3035	0.3063	0.2935
A3	0.2963	0.2851	0.2963	0.2951	0.3013	0.3043	0.3013	0.2943
A4	0.2963	0.2751	0.2963	0.2851	0.3013	0.2943	0.3013	0.2843
A5	0.2913	0.2759	0.2913	0.2859	0.2963	0.2951	0.2963	0.2851
A6	0.2913	0.2659	0.2913	0.2759	0.2963	0.2851	0.2963	0.2751
A7	0.2863	0.2667	0.2863	0.2767	0.2913	0.2859	0.2913	0.2759
A8	0.2863	0.2567	0.2863	0.2667	0.2913	0.2759	0.2913	0.2659
A9	0.2813	0.2575	0.2813	0.2675	0.2863	0.2767	0.2863	0.2667
B1	0.2813	0.2475	0.2813	0.2575	0.2863	0.2667	0.2863	0.2567
B2	0.2763	0.2483	0.2763	0.2583	0.2813	0.2675	0.2813	0.2575
B3	0.2763	0.2383	0.2763	0.2483	0.2813	0.2575	0.2813	0.2475
B4	0.2713	0.2391	0.2713	0.2491	0.2763	0.2583	0.2763	0.2483
B5	0.2713	0.2291	0.2713	0.2391	0.2763	0.2483	0.2763	0.2383
B6	0.2663	0.2299	0.2663	0.2399	0.2713	0.2491	0.2713	0.2391
B7	0.2663	0.2199	0.2663	0.2299	0.2713	0.2391	0.2713	0.2291
B8	0.2613	0.2207	0.2613	0.2307	0.2663	0.2399	0.2663	0.2299
B9	0.2613	0.2107	0.2613	0.2207	0.2663	0.2299	0.2663	0.2199

### 1.7 Typical Optical Characteristics Curves

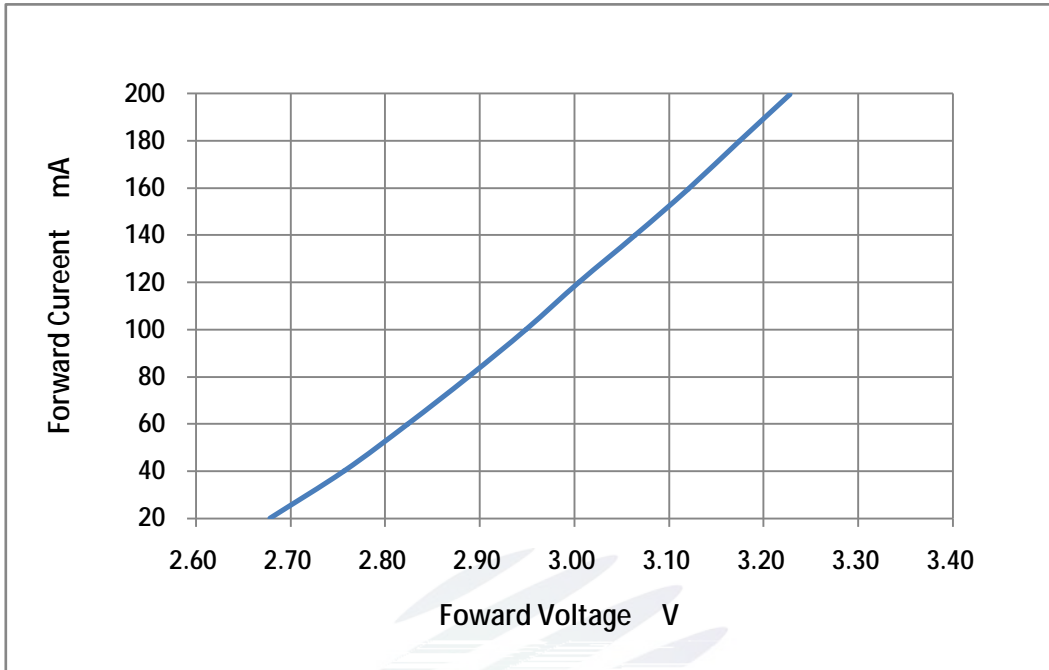

Fig. 1-7 Forward Voltage Vs Forward Current

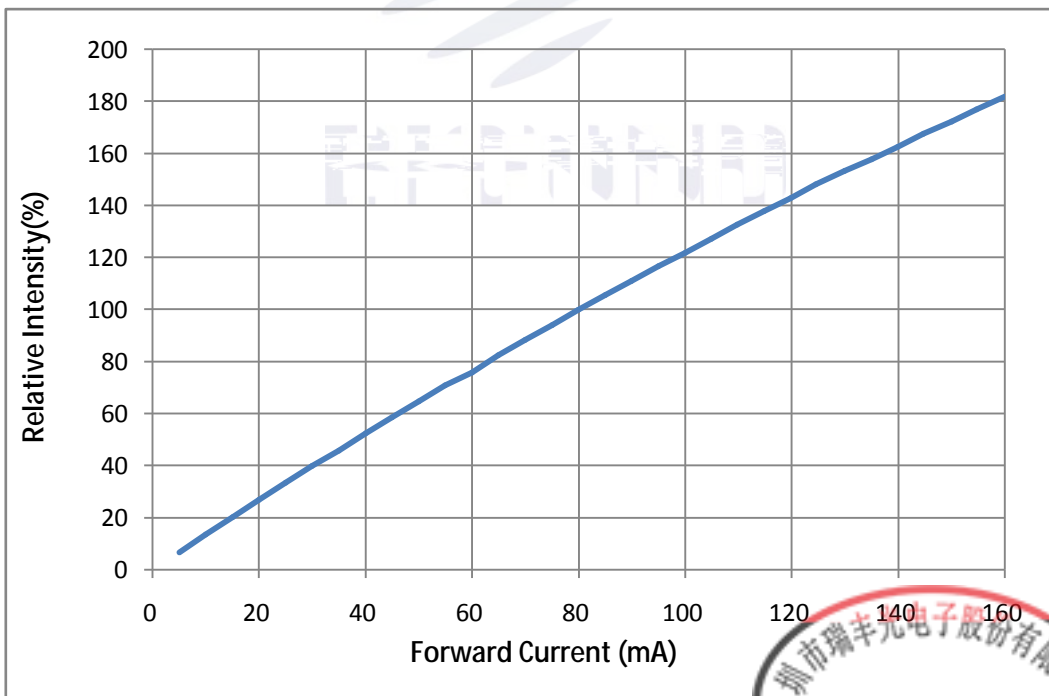
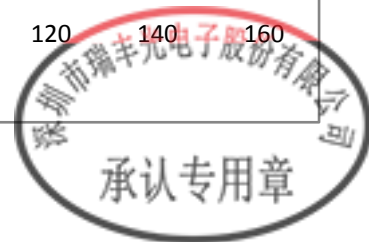

Fig. 1-8 Forward Current Vs Relative Intensity







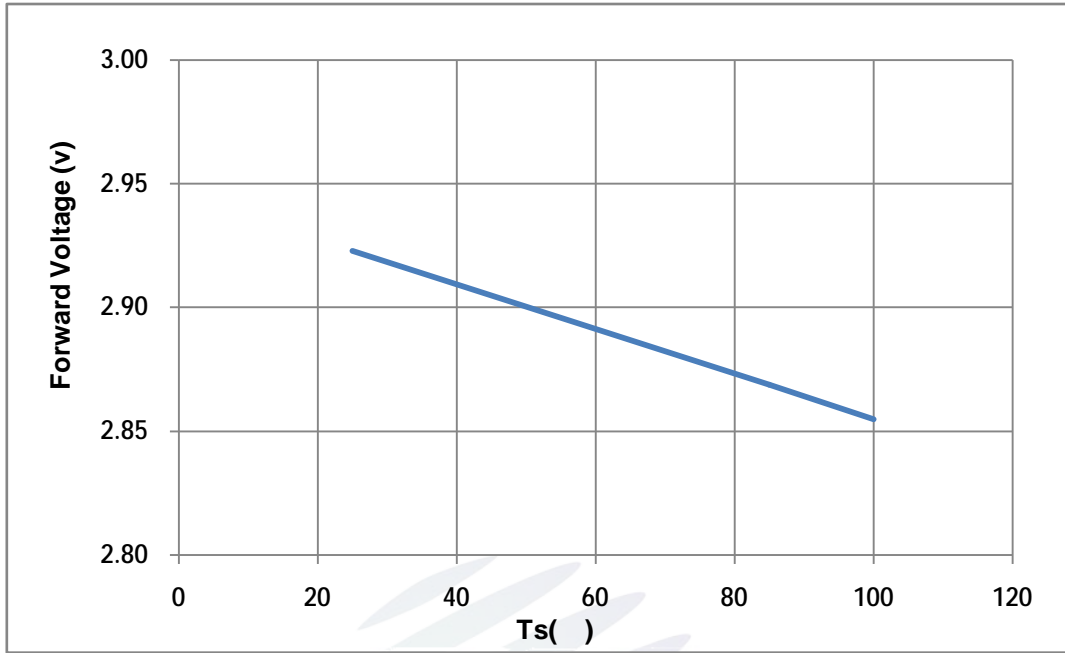

Fig. 1-11 Forward Voltage Vs Solder Temperature

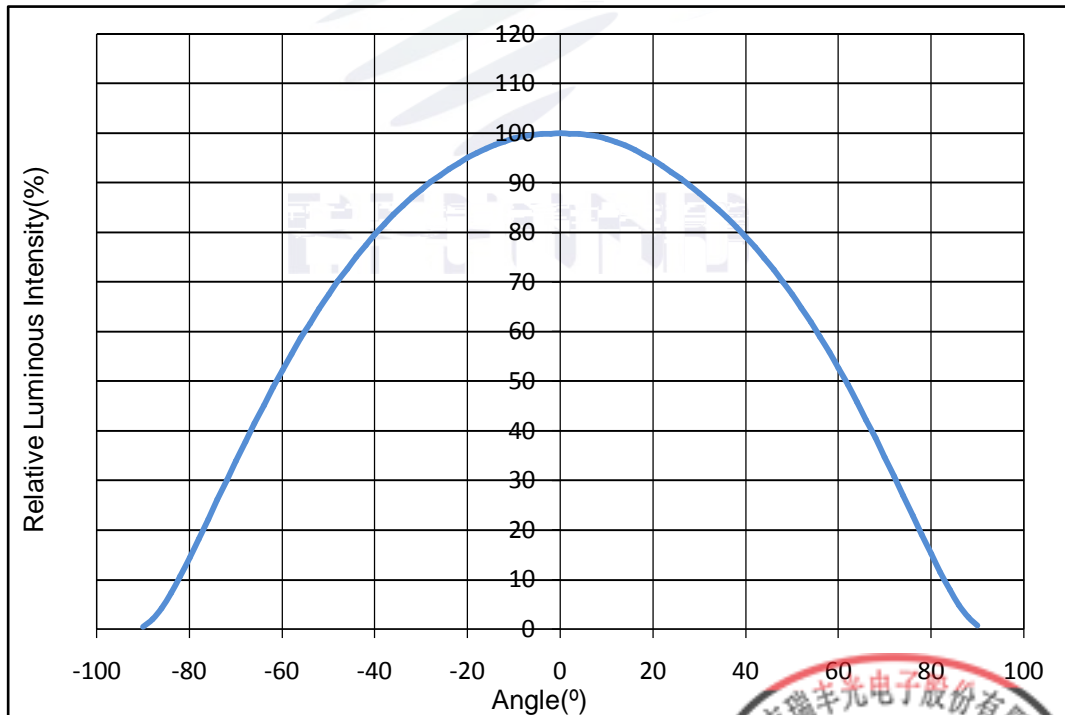
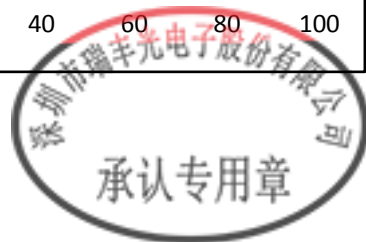

Fig. 1-12 Radiation diagram



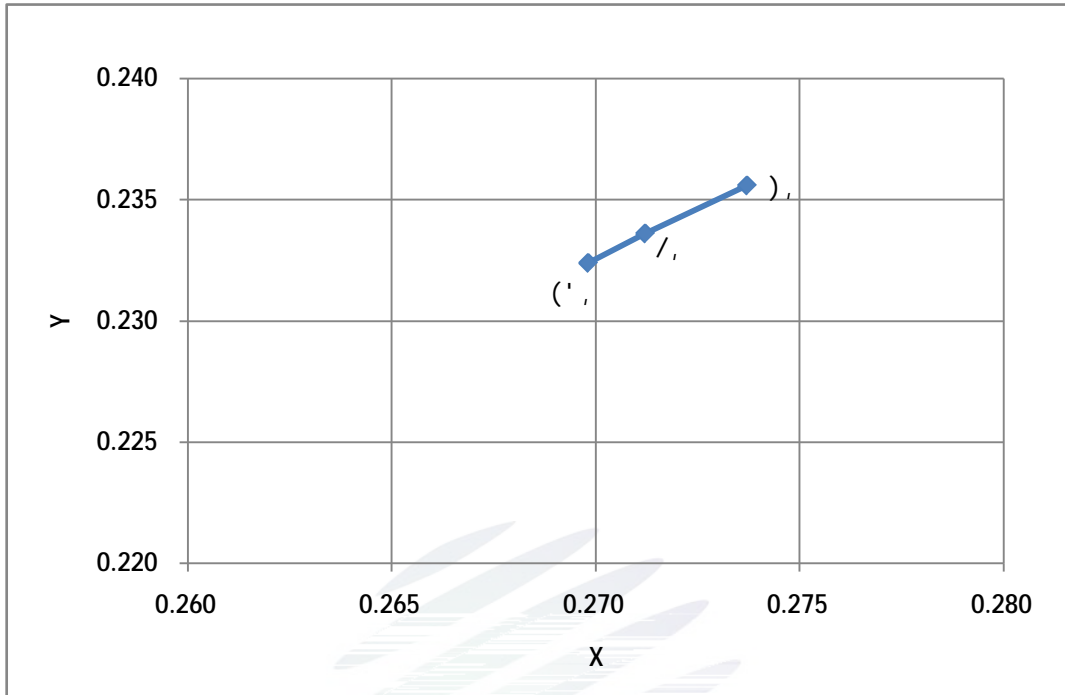

Fig. 1-13 Forward Current vs. Color Shift (Ts=25°C)

(Ts=25°C)

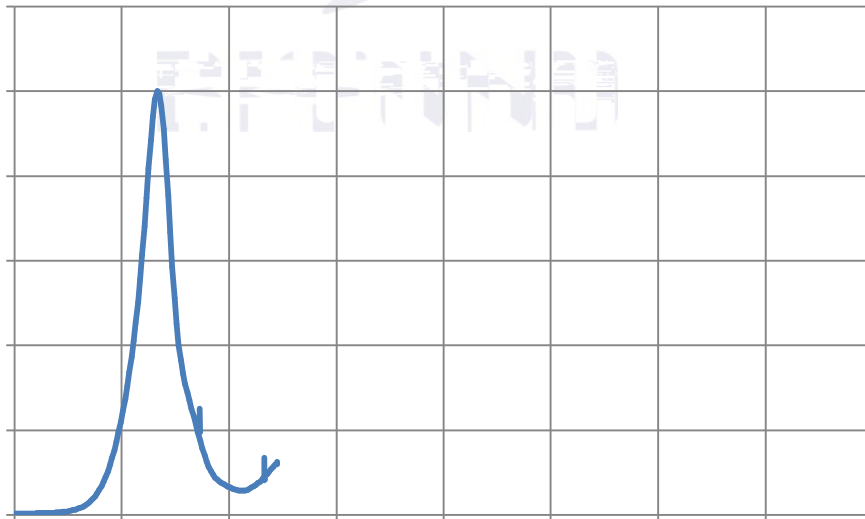

Fig. 1-14 Spectrum Distribution

## 2. Packaging

### 2.1 Packaging Specification

Package: 5000pcs/reel. 5000pcs

#### 2.1.1 Carrier Tape Dimension mm



Fig.2-1 Carrier Tape Dimension

#### 2.1.2 Reel Dimension

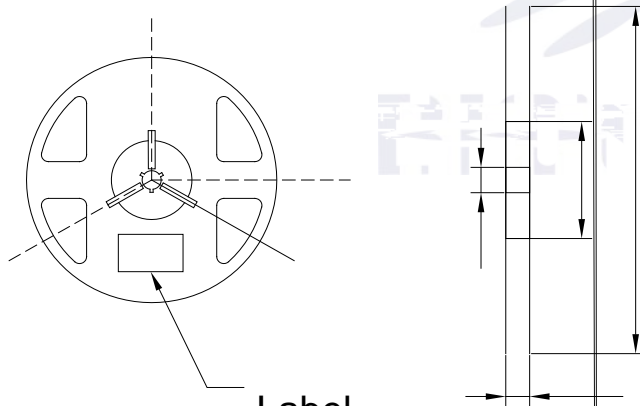

Label  
Fig.2-2 Reel Dimension

Table 2-1 Reel Dimension

A	8.0...0.1mm
B	178...1mm
C	60...1mm
D	13.0...0.5mm

#### Notes

The tolerances unless mentioned  $\pm 0.1\text{mm}$ . Unit : mm

...! %



## 2.4 Reliability Test Items And Conditions

Table 2-3 Reliability Test Items And Conditions

Test Items	Ref.Standard	Test Condition	Time	Quantity	Ac/Re /
Reflow	JESD22-B106	Temp:260 max T=10 sec	2times	20pcs.	0/1
MSL2 2	JESD22-A113	85 / 60%RH	168 hrs.	20pcs.	0/1

Thermal Shock	JEITAED-4701 300307	-40 15min	1000 cycle	20pcs.	0/1
		10s			
		125 15min			

## 2.5 Criteria For Judging Damage

Table 2-4 Criteria For Judging Damage

Test Items	Symbol	Test Condition	Criteria For Judgement	
			Min.	Max.
Forward Voltage	$V_F$	$I_F=80mA$	-	U.S.L*)x1.1
Reverse Current	$I_R$	$V_R = 5V$	-	U.S.L*)x2.0
Luminous Flux		$I_F=80mA$	L.S.L*)x0.7	-

### Notes

- 1.U.S.L: Upper standard level                      L.S.L: Lower standard level
- 2.The above reliability tests is based on the verification of a single/strip LED of Refond's existing experimental platform,the reliability experiment was taken under good heat dissipation conditions. when customers applies the LED to the series and parallel circuit, should take consideration of all the factors such as the current, voltage distribution, heat dissipation and others. / LED  
LED
- 3.The technical information shown in the data sheets is limited to the typical characteristics and circuit examples of the referenced products. It does not constitute the warranting of industrial property nor the granting of any license.



### 3. SMT Reflow Soldering Instructions SMT

#### 3.1 SMT Reflow Soldering Instructions SMT

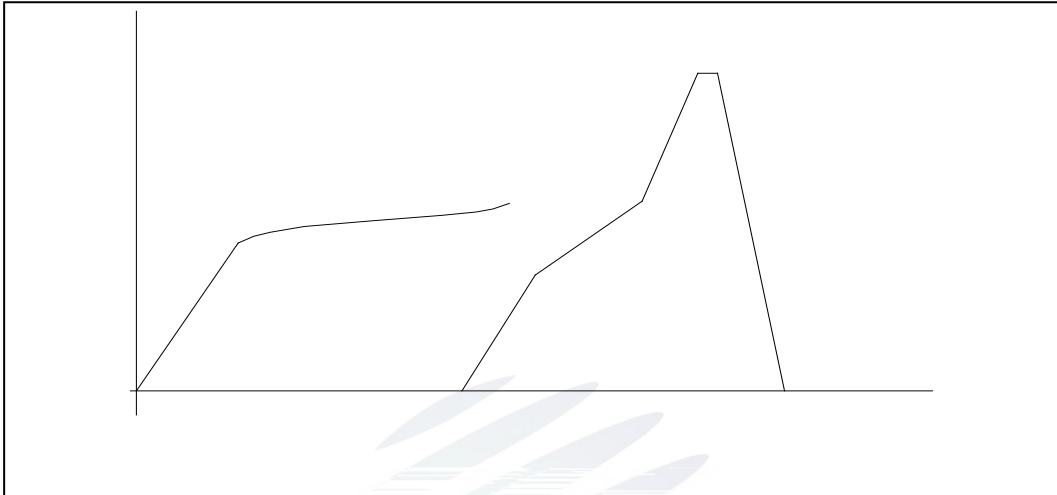

Fig.3-1 SMT Reflow Soldering Instructions SMT

Table 3-1 Reflow parameters

Average temperature rise speed	$T_{smax}$ $T_P$	3 °C/ Max 3 °C/ s
Preheating: minimum temperature	( $T_{smin}$ )	150 °C
Preheating: Max temperature	( $T_{smax}$ )	200 °C
Preheating: Time	$T_{smin}$ $T_{smax}$	60 - 120 60s-120s
Time limited to maintain high temperature: the temperature	( $T_L$ )	217 °C
Time limited to maintain high temperature: The Time	( $t_L$ )	60 Max 60s
Peak /Classification of temperature:	/ ( $T_P$ )	260 °C
Time limit classification of peak temperature time	$t_p$	10 Max 10s
( $T_P$ ) 5 °C Hold time within 5 °C with the actual peak temperature (TP)		30 Max 30s
Cooling speed		6 °C/ Max 6 °C/ s
25 °C Needed time from 25 °C to $T_p$		8 Max 8 minutes



Notes

(1)Reflow soldering should not be done more than twice. If more than 24 hours between the two solderings , LED will be damaged. 24 LED

(2)When soldering , do not put stress on the LEDs during heating.

3.1.1 Repairing

(1) Repairing should not be done after the LEDs have been soldered. When repairing is unavoidable,a double-head soldering iron should be used (as below figure). It should be confirmed in advance whether the characteristics of LEDs will or not be damaged by repairing.

(2) LED LED

3.1.2 Cautions

(1) The encapsulated material of the LEDs is silicone. Therefore the LEDs have a soft surface on the top of package. The pressure to the top surface will be impacted on the reliability of the LEDs. Precautions should be taken to avoid the strong pressure on the encapsulated part. So when use the picking up nozzle, the pressure on the silicone resin should be proper. LED LED

(2) Components should not be mounted on warped (non coplanar) portion of PCB. After soldering, do not warp the circuit board.LED PCB

(3) Do not apply mechanical force or excess vibration during the cooling process to normal temperature after soldering. Do not rapidly cool device after soldering.



## 4. Handling Precautions

### 4.1 Handling Precautions

(1) LED operating environment and sulfur element composition cannot be over 100PPM in the LED mating usage material. This is provided for informational purposes only and is not a warranty or endorsement.LED

LEt.LED



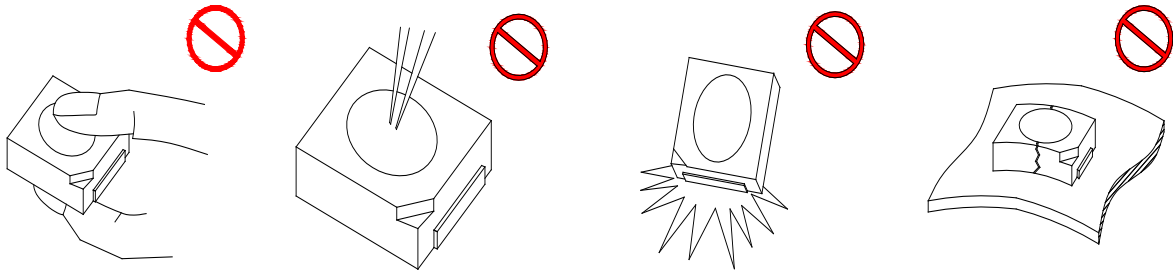

Fig 4-1 Handling Precautions

(5) In designing a circuit, the current through each LED can not exceed the absolute maximum rating specified for each LED. In the mean while, resistors for protection should be applied, other wise slight voltage shift will cause big current change, burn out may happen. The driving circuit must be designed to allow forward voltage only when it is ON or OFF. If the reverse voltage is applied to LED, migration can be generated resulting in LED damage.

LED

LED

(6) Thermal Design is paramount importance because heat generation may result in the Characteristics decline, such as brightness decreased, Color change and so on. Please consider the heat generation of the LEDs when making the system design.

LED

(7) Compared to standard encapsulants, silicone is generally softer, and the surface is more likely to attract dust, requiring special care during processing. In cases where a minimal level of dirt and dust particles cannot be guaranteed, a suitable cleaning solution must be applied to the surface after the soldering of components. Refond suggests using isopropyl alcohol for cleaning. In case other solvents are used, it must be assured that these solvents do not dissolve the package or resin. Ultrasonic cleaning is not recommended. Ultrasonic cleaning may cause damage to the LED.

LED

Table 4-1 Storage

Conditions		Temperature	Humidity	Time
Storage	Before Opening Aluminum Bag	30	75%	Within 1 Year From Date
	After Opening Aluminum Bag	30	60%	Recommended for use within 24 hours 24
Baking		60±5	-	24hours 24

(8) If the moisture absorbent material silica gel has faded away or the LEDs have exceeded the storage time, baking treatment should be performed after unpacking and based on the following condition  $60 \pm 5$  for above 24 hours.

$60 \pm 5$  24

If the package is flatulence or damaged, please notify the sales staff to assist.

(9) Similar to most Solid state devices; LEDs are sensitive to Electro-Static Discharge (ESD) and Electrical Over Stress (EOS). LED

(10) Other points for attention, please refer to our relevant information.







Declare

This specification is written both in English and in Chinese and the latter is formal.

