

SPECIFICATION

REFOND P/N

RF-IPD4428TS-14-G



Mass Product

Contents

1. Description	
1.1 General Description	
1.2 Features	
1.3 Application	
1.4 Package Dimension	
1.5 Product Parameters	
1.6 Typical Optical Characteristics Curves	
2. Packaging	
2.1 Packaging Specification	
2.1.1 Carrier Tape Dimension	10
2.1.2 Reel Dimension	10
2.1.3 Label Form Specification	11
2.2 Moisture Resistant Packing	
2.3 Cardboard Box	
2.4 Reliability Test Items And Conditions	
2.5 Criteria For Judging Damage	
3. SMT Reflow Soldering Instructions SMT	
3.1 SMT Reflow Soldering Instructions SMT	
4. Handling Precautions	
4.1 Handling Precautions	

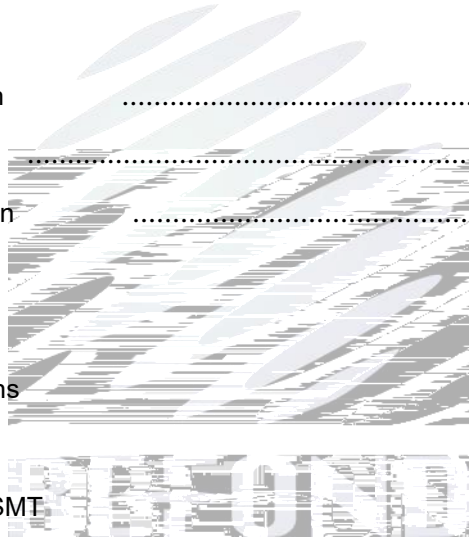

1. Description

1.1 General Description

This product uses the BT package, it has a high reliability.

Size(mm): 4.42mmX2.76mmX3.74mm.

BT

4.42mmX2.76mmX3.74mm.

1.2 Features

- ▶ Low forward voltage.
- ▶ Peak wavelength $\lambda_p=940\text{nm}$. $\lambda_p=940\text{nm}$
- ▶ Suitable for all SMT assembly and solder process.
- ▶ Moisture sensitivity level: Level 3.
- ▶ RoHS compliant.

1.3 Application

- ▶ Touch Panel.
- ▶ Electronic Equipment.
- ▶ Safety Systems.
- ▶ Industrial Automation.



1.4 Package Dimension

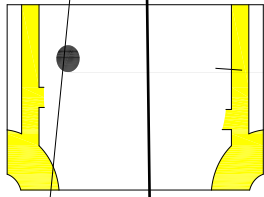

Fig.1-1 Top view

Fig.1-2 Bottom view



Fig.1-3 Side view

Fig.1-4 Polarity

Fig.1-5 Soldering patterns

Notes

All dimensions units are millimeters.

All dimensions tolerances are $\pm 0.2\text{mm}$ unless otherwise noted.

1.5 Product Parameters

Table 1-1 Electrical / Optical Characteristics at Ts=25°C

Item	Symbol	Test Condition	Value			Unit
			Min.	Typ	Max.	
Reverse Current	I_R	$V_R=5V$	---	---	5	uA
Forward Voltage	V_F	$I_F=50mA$	1.1	1.3	1.6	V
Peak Wavelength	λ_p	$I_F=50mA$	---	940	---	nm
Spectrum Radiation Bandwidth	$\Delta\lambda$	$I_F=50mA$	---	45	---	nm
Radiant Intensity	Φ_e	$I_F=50mA$	60	---	---	mW/sr
Viewing Angle	2θ1/2	$I_F=50mA$	---	30	---	deg
Thermal Resistance.	R_{THJ-S}	$I_F=50mA$	---	450	---	/W

Notes : $V_R=5V$ For test conditions: $V_R=5V$

Table 1-2 Absolute Maximum Ratings at Ts=25°C

Parameter	Symbol	Rating	Units
Power Dissipation	P _D	150	mW
Forward Current	I _F	100	mA
Peak Forward Current Of Pulse	I _{FP}	1000	mA
Reverse Voltage	V _R	5	V
Electrostatic Discharge (HBM)	E _{SD}	2000	V
Operating Temperature	T _{OPR}	-25 ~ +85	
Storage Temperature	T _{OPR}	-40 ~ +100	
Junction Temperature	T _J	95	

Notes

- 1/10 Duty cycle, 0.1ms pulse width.
- The above forward voltage measurement allowance tolerance is ±0.1V.
- The above dominant wavelength measurement allowance tolerance is ±2nm.
- The above luminous intensity measurement allowance tolerance ±10%.
- Care is to be taken that power dissipation does not exceed the absolute maximum rating of the product.
- All measurements were made under the standardized environment of Refond.
- When the LEDs are in operation the maximum current should be decided after measuring the package temperature, junction temperature should not exceed the maximum rate

1.6 Typical Optical Characteristics Curves

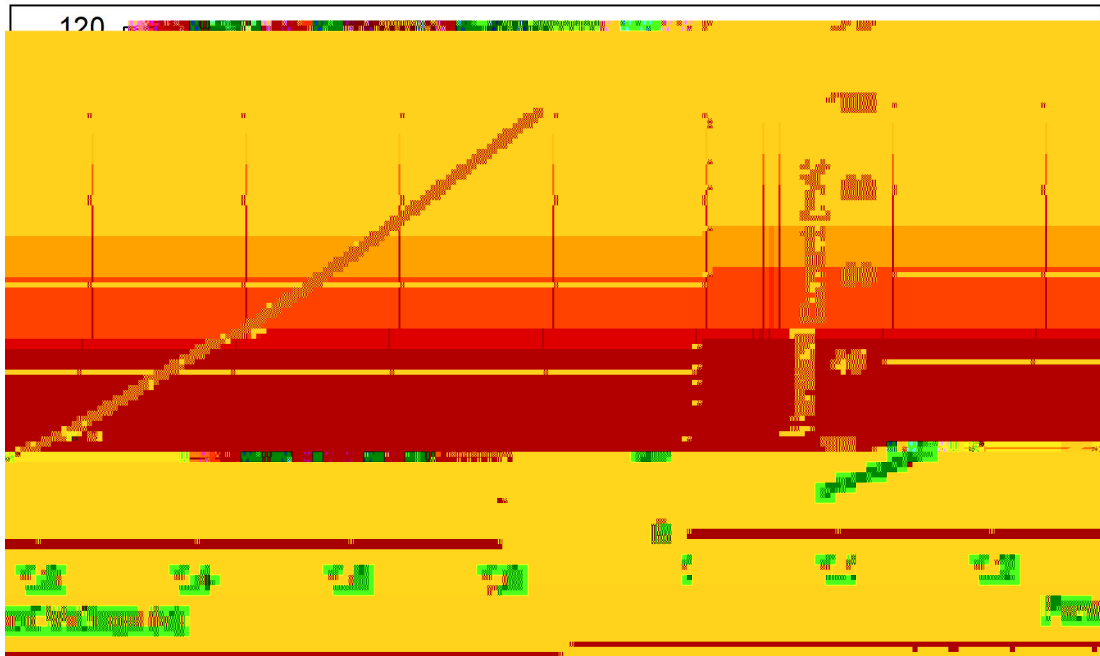

Fig 1-6 Forward Voltage Vs Forward Current

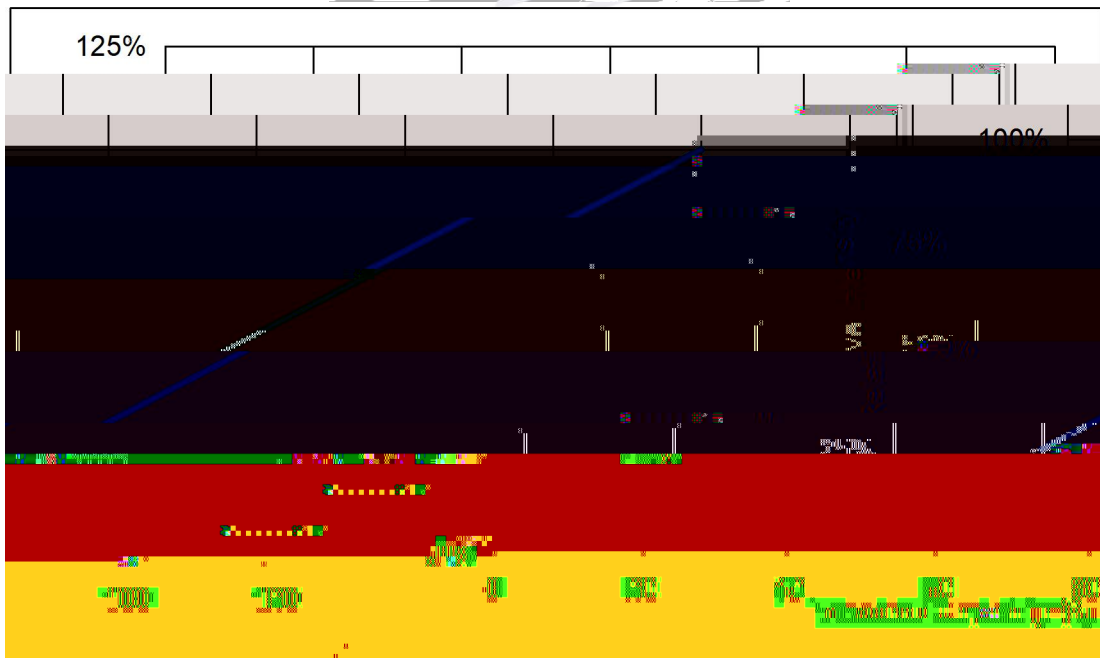

Fig 1-7 Forward Current Vs Relative Intensity

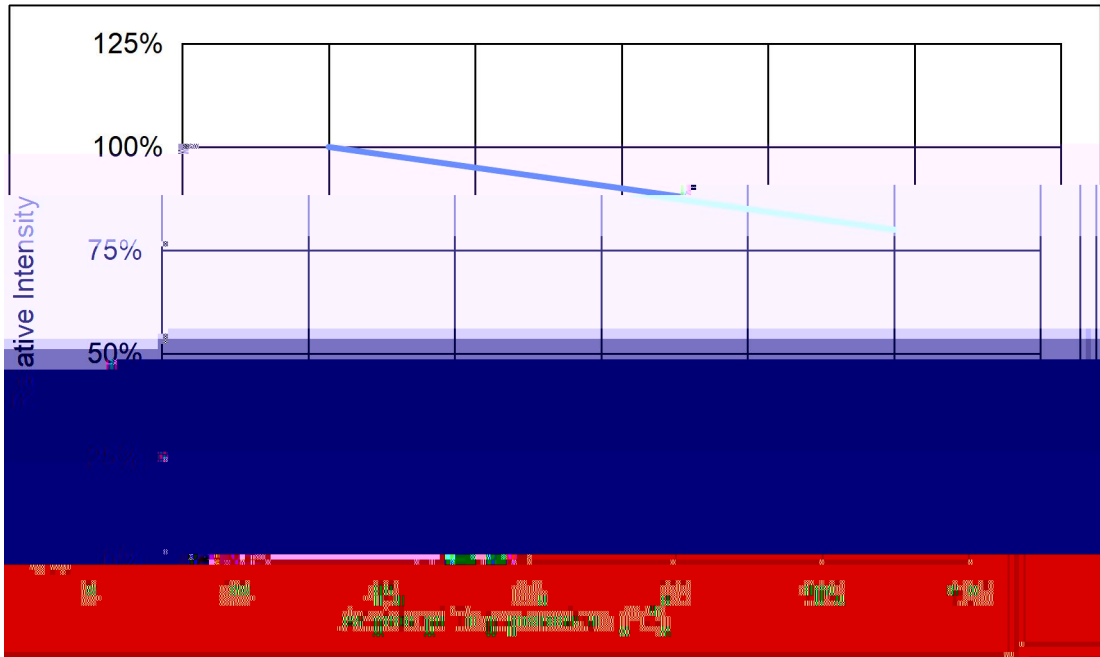

Fig 1-8 Pin Temperature Vs Relative Intensity

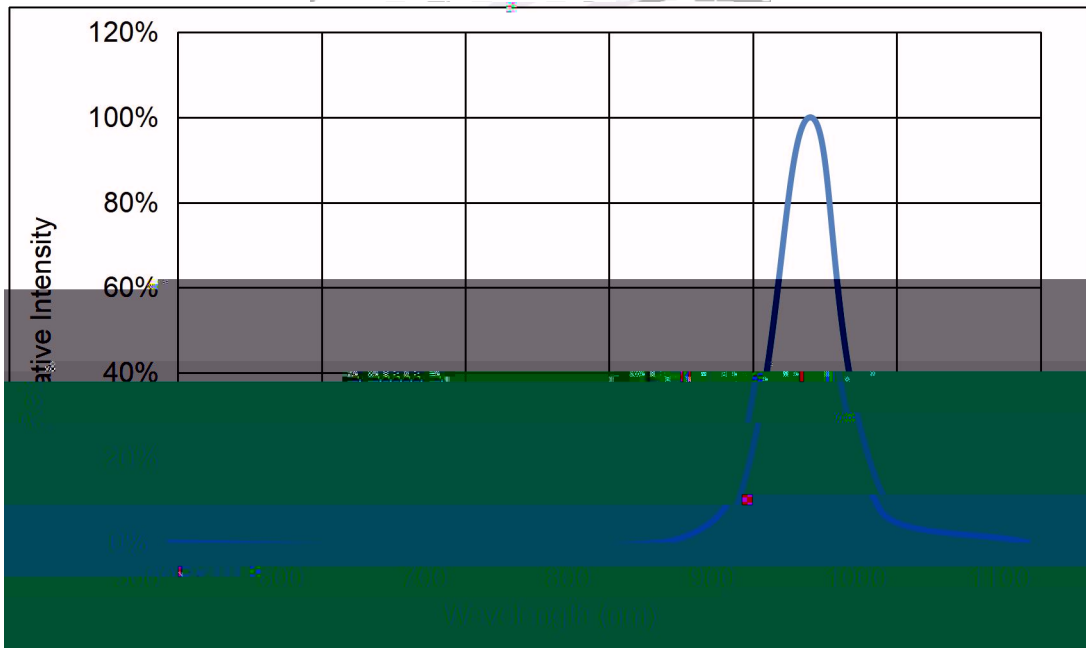
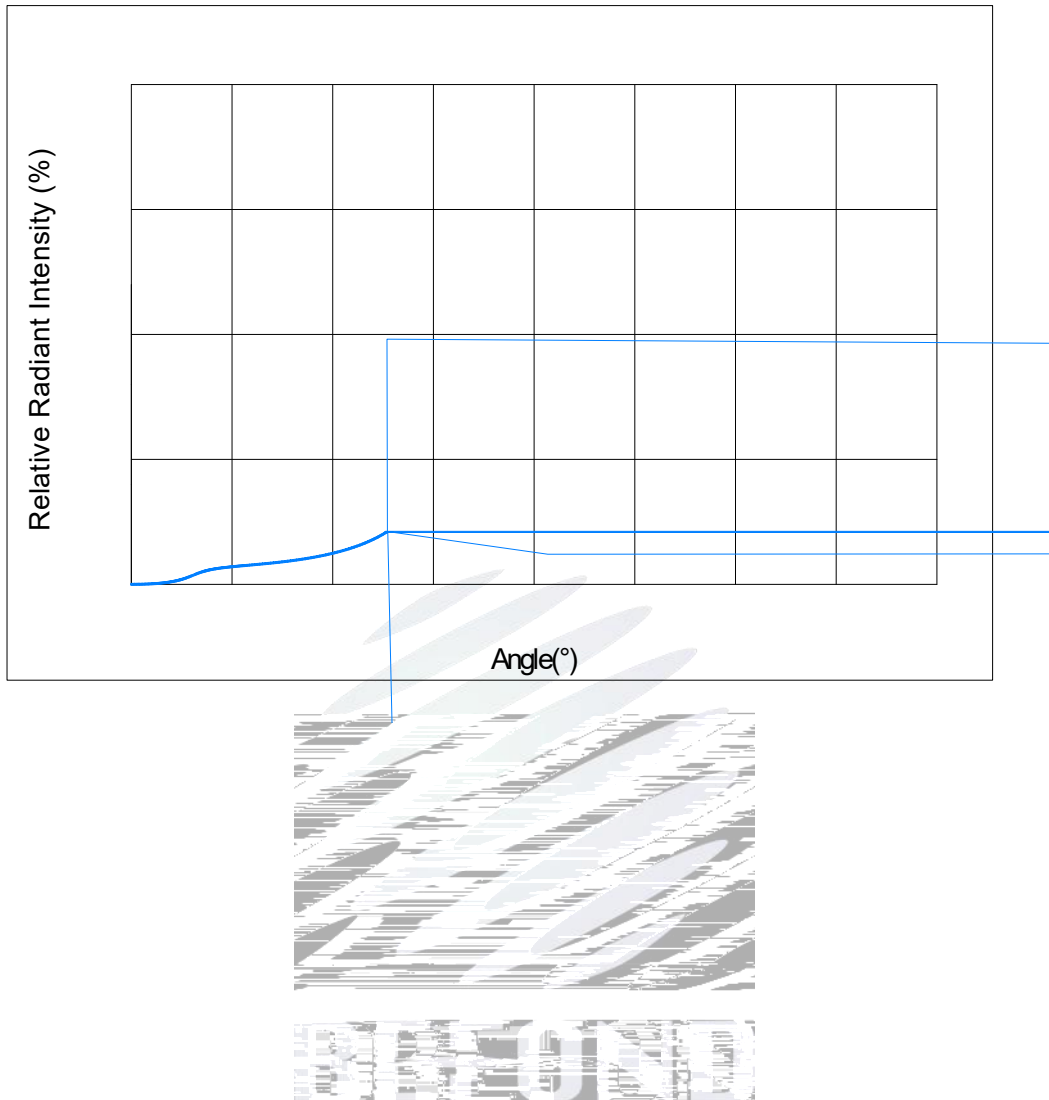

Fig 1-9 Spectrum Distribution



2. Packaging

2.1 Packaging Specification

Package:2000pcs/reel. 2000pcs

2.1.1 Carrier Tape Dimension

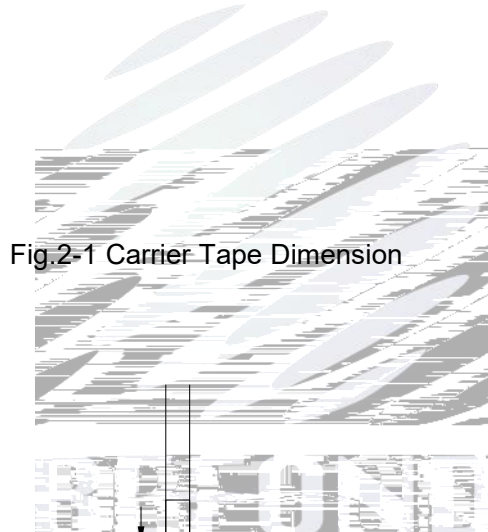

Fig.2-1 Carrier Tape Dimension

2.1.2 Reel Dimension

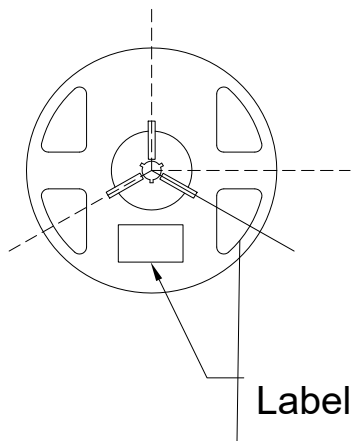

Fig.2-2 Reel Dimension

Table 2-1 Dimension

A	12.7 ±0.3mm
B	330.2±2mm
C	79.5±1mm
D	14.3±0.2mm

Notes

The tolerances unless mentioned ± 0.1 mm. Unit : mm

2.1.3 Label Form Specification

Table 2-2 Parameter

PART NO	Part Number
SPEC NO	Spec Number
LOT NO	Lot Number
BIN CODE	Bin Code
Ie	Radiant Intensity
WLP	Peak Wavelength
VF	Forward Voltage
QTY	Packing Quantity
DATE	Made Date

Fig. 2-3 Label Form Specification

2.2 Moisture Resistant Packing



Fig.2-4 Moisture Resistant Packing

2.3 Cardboard Bo

Fig.2-5 Cardboard Box

2.4 Reliability Test Items And Conditions

Table 2-3 Reliability Test Items And Conditions

Test Items	Ref.Standard	Test Condition	Time	Quantity	Ac/Re /
Reflow	JESD22-B106	Temp:260 max T=10 sec	2 times	22Pcs.	0/1
Temperature Cycle	JESD22-A104	100 30 min ↑↓5 min -40 30 min	100 cycles	22Pcs.	0/1
Thermal Shock	JESD22-A106	-40 15min ↑↓ 100 15min	300 cycles	22Pcs.	0/1
High Temperature Storage	JESD22-A103	Temp:100	1000 hrs.	22Pcs.	0/1
Low Temperature Storage	JESD22-A119	Temp:-40	1000 hrs.	22Pcs.	0/1
Life Test	JESD22-A108	T _a =25 I _F =100mA	1000 hrs.	22Pcs.	0/1



Reflow Soldering Instructions SMT

3.1 SMT Reflow Soldering Instructions SMT

SMT Reflow Soldering Instructions SMT

Table 3-1 Parameter

Averag

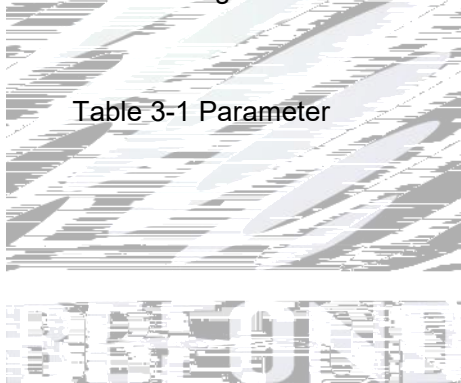

豐光

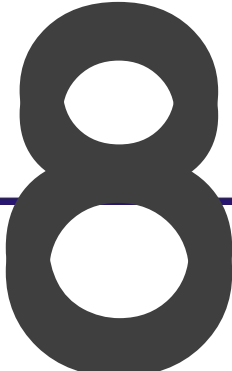
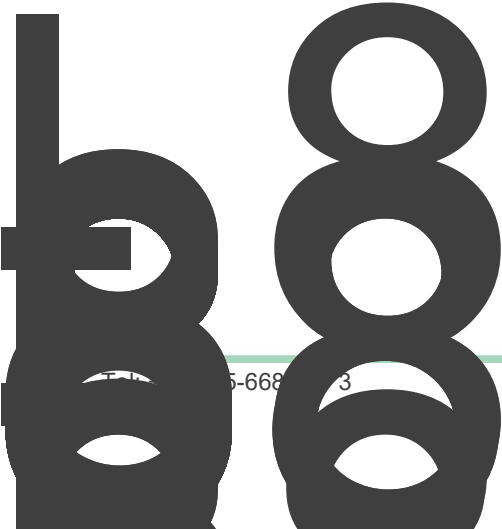
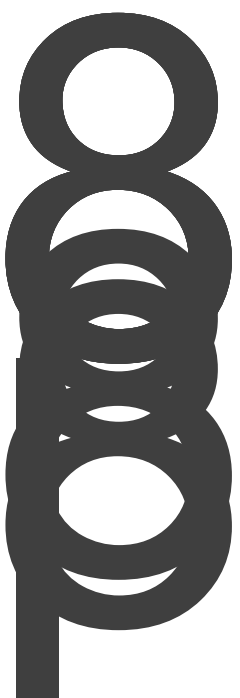
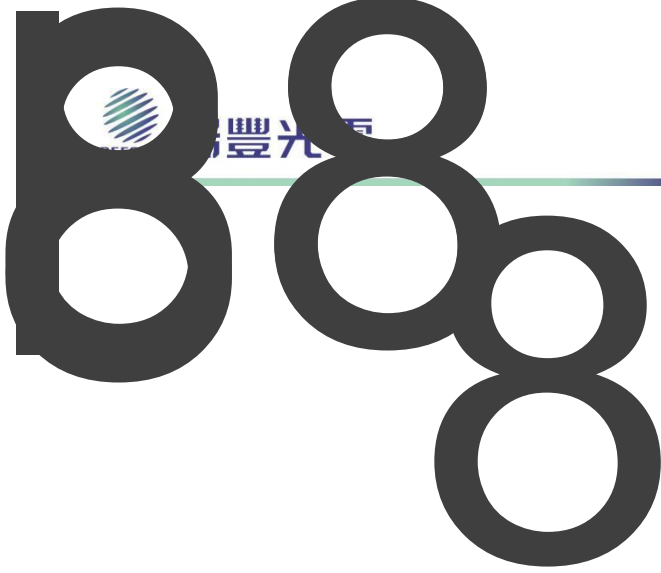

5-668 3

創新科技. 豐富生活!
Innovation with life

4. Handling Precautions

4.1 Handling Precautions

(1) LED operating environment and sulfur element composition cannot be over 100PPM in the LED mating usage material. This is provided for informational purposes only and is not a warranty or endorsement. LED

(2) In order to prevent external material from getting into the inside of LED, which may cause the malfunction of LED, the single content of Bromine element is required to be less than 900PPM, the single content of Chlorine element is required to be less than 900PPM, the total content of Bromine element and Chlorine element in the external materials of the application products is required to be less than 1500PPM. This is provided for informational purposes only and is not a warranty or endorsement.

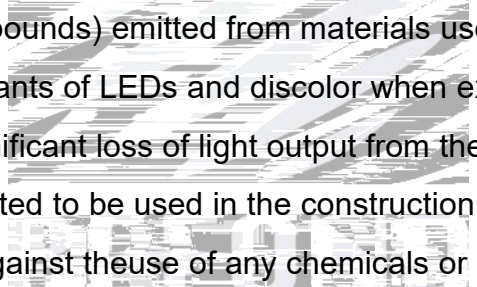

(3) VOCs (Volatile organic compounds) emitted from materials used in the construction of fixtures can penetrate silicone encapsulants of LEDs and discolor when exposed to heat and photonic energy. The result can be a significant loss of light output from the fixture. Knowledge of the properties of the materials selected to be used in the construction of fixtures can help prevent these issues. Refond advises against the use of any chemicals or materials that have been found or are suspected to have an adverse effect on device performance or reliability. To verify compatibility, Refond recommends that all chemicals and materials be tested in the specific application and environment for which they are intended to be used. Attaching LEDs, do not use adhesives that outgas organic vapor.

(4) In designing a circuit, the current through each LED can not exceed the absolute maximum rating specified for each LED. In the meanwhile, resistors for protection should be applied,

(8) Similar to most Solid state devices; LEDs are sensitive to Electro-Static Discharge (ESD) and Electrical Over Stress (EOS).

(9) Other points for attention, please refer to our relevant information.





Declare

This specification is written both in English and in Chinese and the latter is formal.